

AirPrime™

Operation and Installation Guide

All AirPrime Models

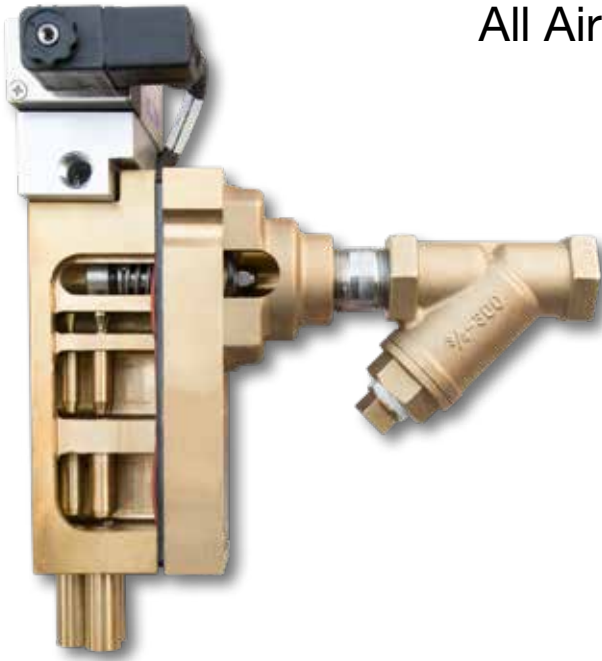

Automatic Controls

Lift Gauge Option ▶

▼ Standard Control



AirPrime Pressure Regulator
For use with high pressure SCBA cylinders

Manual Controls

◀ Lift Gauge Option

Standard Control ▼

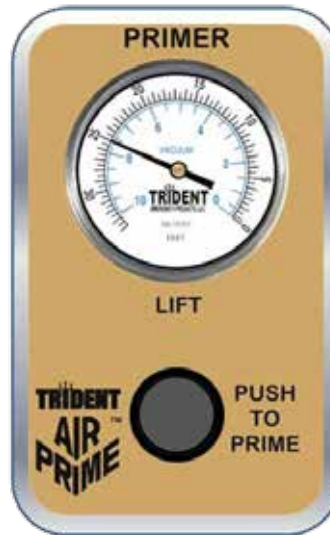

Contents

Available Models	2
AirPrime™ Overview	2
AirPrime™ - How Does It Work.....	3
Installer Responsibilities.....	4
Air Schematic, PPV, Air Hose and Connections.....	5
Automatic Single Location AirPrime™ System	6
Automatic Single Location AirPrime™ System with Optional Vacuum Gauge	7
Manual Single Location AirPrime™ Systems.....	8
Multi Location Installation and Operating Instructions.....	9
Multi Location Automatic AirPrime™ System Diagram.....	10
Multi Location Manual AirPrime™ System Diagram	11
Trouble Shooting Guide.....	12
Trouble Shooting Guide (Continued)	13
AirPrime™ Industrial and SC Systems.....	13
Annual Primer Testing.....	14
Warranty and Product Information	15
Repair/Replacement Parts	16

Available Models

Automatic Control

- Automatic Base Model
- Automatic Base Model with Lift Gauge
- Automatic Multi Location
- Automatic Multi Location with Lift Gauge

Manual Control

- Manual Base Model
- Manual Base Model with Lift Gauge
- Manual Multi Location
- Manual Multi Location with Lift Gauge



AirPrime™ Overview

Trident has several AirPrime models to meet your specific operational requirements.

Base Models: All models available in 2 or 3 barrel design (depending on your water pump capacity and chassis air compressor size CFM).

Direct Mount: Models bolt directly to a Hale Q Model midship pump's priming port with two bolts. The Hale pump model name must begin with a Q. e.g. Qmax.

Remote Mount: This type can be used with any pump, have a 3/4" female NPT connection and require a simple bracket to hold the unit to the frame.

Multi-Location: Priming from multiple locations.

Variations and Options:

1. The AirPrime is available in either manual and automatic single location models.
1. Multi-Location AirPrime is available in manual or automatic models.
2. Automatic versions are available in 12 and 24 Volt models.
3. Lift Gauge which indicates how much vacuum (in feet-of-water) the primer is creating to prime the pump.
4. Conversion Kits for Manual to Automatic and for adding more locations are available. Refer to Page 16.
5. AirPrime is also available for small trucks without air brakes. See Page 5 for additional information.

For more information on all available models please visit: www.TridentDirect.com or www.TridentAutoAirPrime.com

AirPrime™ - How Does It Work

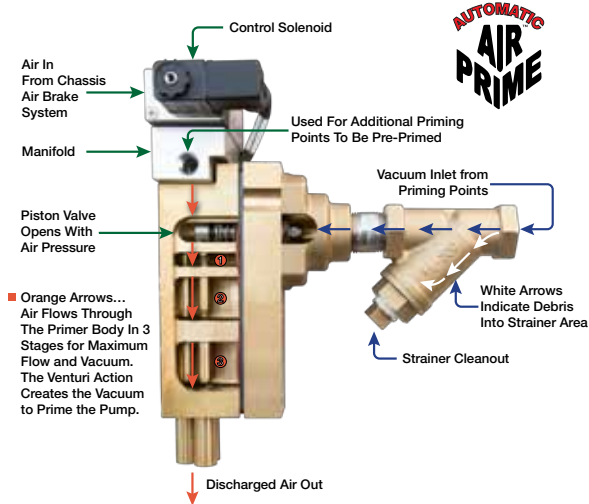

How Does It Work?

AirPrime utilizes air supplied from the chassis air brake compressor to operate the fire pump primer. This is proven to be far more efficient and reliable than electric motor driven rotary vane primers.

AirPrime virtually eliminates the impact load on the electrical system improving vehicle reliability.

AirPrime also improves performance in the elapsed time for establishing water supply resulting in improved fire ground operations and safety.

Auto Prime Move Switch to the upper position. The Green LED light will illuminate. The primer will activate when the OK TO PUMP light is ON and the Pump Pressure is below 20 PSIG.

The Auto Mode only operates when the fire pump is engaged.

Off Position

Incoming Air Flow **OFF**.

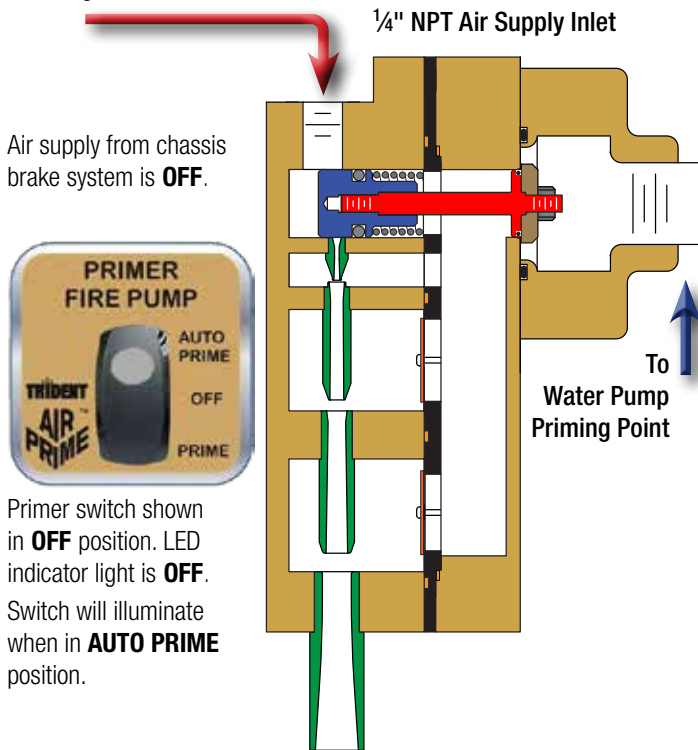

Air supply from chassis brake system is **OFF**.

Primer switch shown in **OFF** position. LED indicator light is **OFF**. Switch will illuminate when in **AUTO PRIME** position.

Auto Prime Position

Incoming Air Flow **OPEN**.

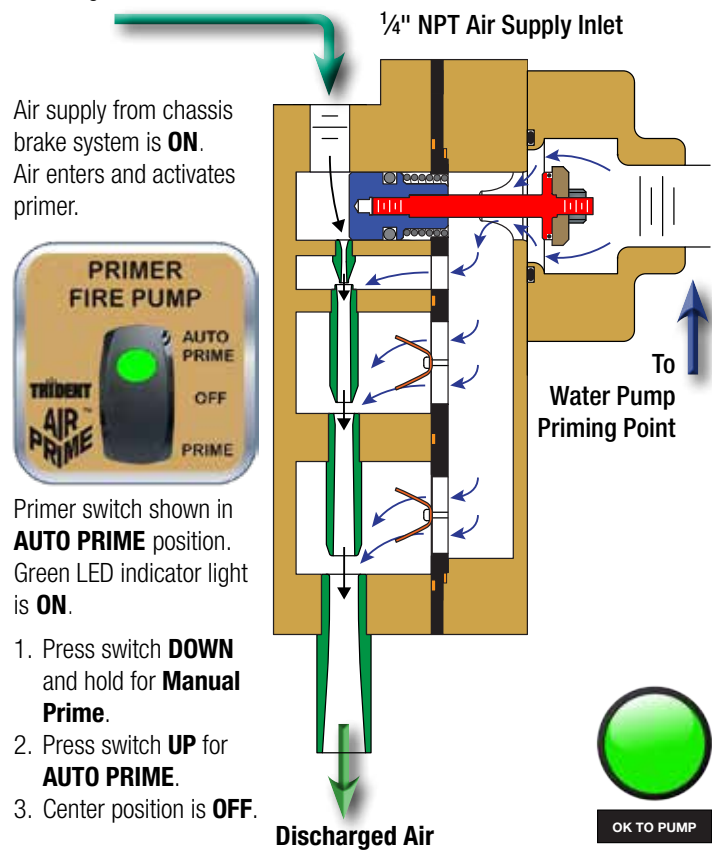

Air supply from chassis brake system is **ON**. Air enters and activates primer.

Primer switch shown in **AUTO PRIME** position. Green LED indicator light is **ON**.

1. Press switch **DOWN** and hold for **Manual Prime**.
2. Press switch **UP** for **AUTO PRIME**.
3. Center position is **OFF**.



NFPA #1901 and #1906 – Fully Compliant to Standards
Pump Panel Noise Level – Lowest dB in the Industry

AirPrime Primers can be used for both New and Retro-Fit installations. In Retro-Fit scenarios, AirPrime may be used to augment the existing primer or as a complete replacement. Automatic AirPrime models provide instant re-priming of the pump when required.

An existing rotary vane primer can be upgraded to an Automatic Primer by adding a single location Auto AirPrime.

Installer Responsibilities

Air Compressor Size

1. The 2-barrel AirPrime must be used only on fire pumps rated 1000 GPM [3800LPM] and less. The chassis shall be equipped with a minimum of 13.2 CFM [0.374 Cubic Meters per Minute] air compressor.
2. The 3-barrel AirPrime must be used only on fire pumps rated 1250 GPM [4700LPM] and more. The chassis shall be equipped with a minimum of 15.6 CFM [0.442 Cubic Meters per Minute] air compressor.
3. For Industrial Pumpers The Dual Unit requires an air compressor with greater than 20 CFM [6.09 Cubic Meters per Minute] capacity. The Triple Unit requires an air compressor with greater than 30 CFM [9.14 Cubic Meters per Minute] capacity.

NOTE: For operations above 4000 feet [1219 meters] of elevation and lifts greater than 15 feet [4.5 meters], a minimum air compressor size of 18 CFM [0.510 Cubic Meters per Minute] or larger is required.

Basic Materials Supplied by Installer

1. A 3/8"OD (.251 ID) air hose from the air tank (primary or auxiliary tank) with 1/4" NPT connections (length determined by installer).
2. Primer mounting bracket. (Only required for remote mount.) See Figure #2.
3. Non-collapsible 3/4" minimum inside diameter (ID) air hose from primer to fire pump with 3/4" NPT connections.
4. A Pressure Protection Valve (PPV) (Optionally available from Trident, Part # 30.053.0).
5. A 1-1/4" [32 mm] inside diameter hose may be connected to the primer outlet using a hose clamp to secure it in place. **NOTE:** Loosely tighten this hose clamp to avoid damage to the primer discharge ports. This hose can direct the water that is discharged from the primer to any convenient location under the vehicle. Be sure this hose is properly secured, kept as short as possible, free of any kinks, sharp bends and pitched to allow drainage.
6. Liquid thread sealant or Teflon tape is required for all threaded pneumatic fittings.

NOTE: Use sparingly while applying sealant to avoid blockage of the internal mesh air filter. See Page 5, Figure #5.

Remote Primer Mounting

1. An installer supplied primer bracket shall be installed to secure the primer within the pump enclosure. **The mounting height for all priming components must be ABOVE the highest priming point on suction side of fire pump (or above the highest remote priming valve for multiple location systems) to permit air removal and allow for complete drainage.** See Figure #2 for mounting bolt hole template. **NOTE:** Primer **MUST** be mounted VERTICALLY with the Primer Outlet discharge (round) ports facing downward as shown in Figure #1.
2. Hose from the 3/4" NPT cleanable wye strainer on the primer inlet to the 3/4" NPT fire pump priming port shall be non-collapsible 3/4" minimum inside diameter.
3. The AirPrime and attached wye strainer shall be installed in an accessible location for serviceability per Figure #3 on Page 5. The installer may choose from one of the options below as a method of draining the strainer:
 - a) Remove threaded plug on wye strainer for draining during annual pump service. Refer to Page 13 for Troubleshooting Guide.
 - b) For draining purposes, the strainer may be piped to the Master Drain of the fire pump system by the installer, especially helpful in climates with freezing conditions.
 - c) Alternatively a separate drain with valve and label may be piped to the bottom of the pump enclosure by the installer.

NOTE: If a front suction inlet is provided, a REMOTE PRIMER mounting is required. Refer to drawings of front suction plumbing on Pages 11 and 12.

Primer Mounting

Figure #1 illustrates the proper mounting of the primer to a Hale Q Series cross-frame midship fire pump. Use the black plastic strainer provided with the fire pump from Hale.

Figure #2 shows the dimensions for the tapped holes in the primer body.

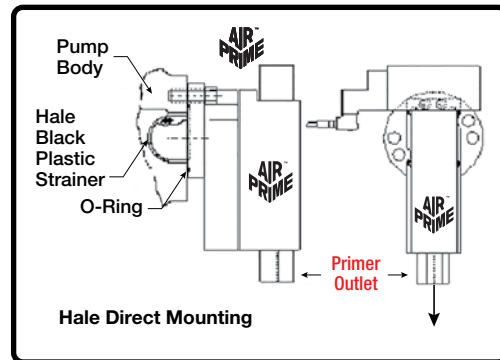

Figure 1

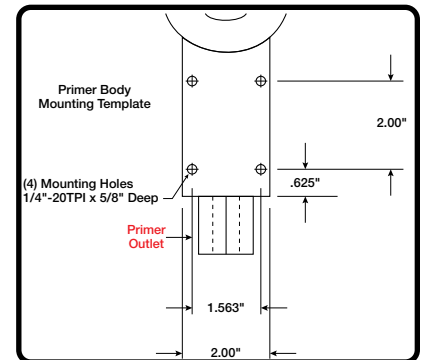

Figure 2

Air Schematic, PPV, Air Hose and Connections

Air Supply Schematic

The AirPrime must be connected to the vehicle's air brake system exactly as shown in **Figure 4** below. The schematic below is typical for most trucks built today.

1. Air compressor supply is shown as ❶.
2. Supply reservoir (wet tank) is shown as ❷.
3. Primary reservoir (typically for the rear brakes) is shown as ❸.
4. Pressure Protection Valve (PPV) is shown as ❹ and in photo at right.
5. **Figure 4a** shows a customer supplied SCBA Cylinder used with the Trident Pressure Regulator for use on trucks without airbrakes. The regulator is available separately as Part #14.013.0.



PPV
#30.053.0
Sold Separately

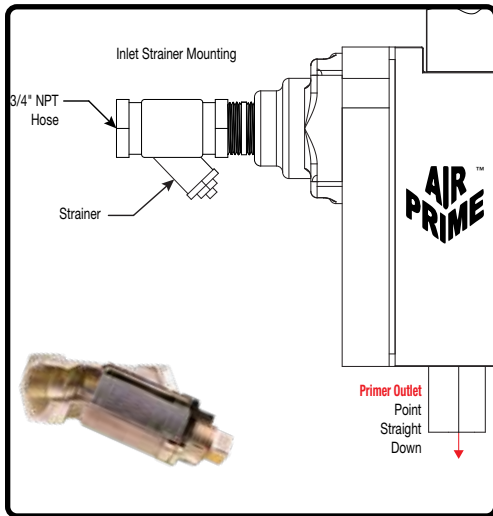

Figure 3

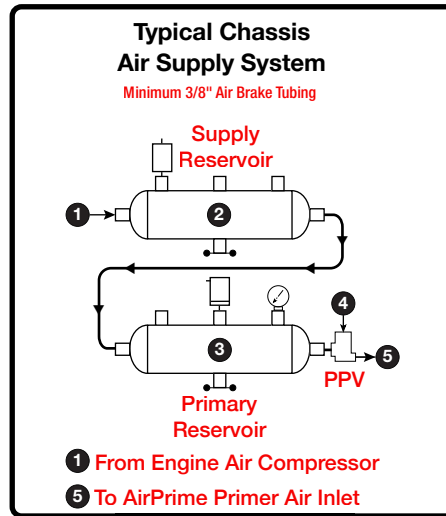

Figure 4

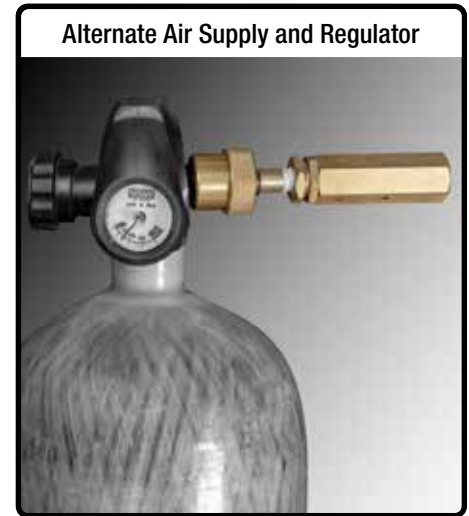

Figure 4a

Air Supply, Hose and Connections

The air source used to supply the AirPrime shall be from the primary air reservoir ❸ in **Figure 4** or a secondary air reservoir (normally used for air horns, air accessories or fire pump shifting system).

The supply line from the Pressure Protection Valve (PPV) ❹ in **Figure 4** to the primer control should be a minimum size of 3/8" OD air brake tubing and connected at both ends with 1/4" NPT fittings (connections and tubing must be rated for air brake service). The tubing should be kept as short as possible, secured at regular intervals, free of any kinks or bends and must not be run near exhaust pipes (Stay 6" [150 mm] away from any exhaust or hot components), muffler, or rotating shafts. Use grommets to protect the tubing lines from contacting sharp edges at hole locations.

When the length of tubing required exceeds 20 feet [6.1 m], a minimum size of 1/2" OD air brake tubing should be used.

Pressure Protection Valve (PPV)

The Pressure Protection Valve (4) is not supplied with the basic primer kit. A Trident PPV, Part #30.053.0 may be purchased separately, a Bendix PPV, Style PR-4, Part #288323 or its equivalent may be used. The PPV valve must be installed per **Figure 4** between the primary air supply reservoir ❸ and the AirPrime primer air inlet. The valve protects the air brake system from any leaks that may occur in the primer control or the line from the PPV to the primer control. The pressure setting for the PPV is 80 PSIG maximum.

Air Filter Port

This cleanable porous filter is located inside the top of the primer body, below the threaded area on the air supply connection or solenoid connection. See **Figure 5**.

A replacement filter is available as Part #21.002.0. When replacing, the domed side faces up.

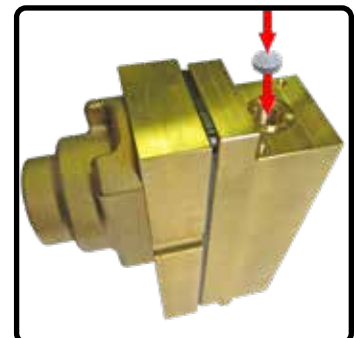

Figure 5

Automatic Single Location AirPrime™ System

Installation

1. Install the AirPrime unit within pump enclosure. Unit must be **VERTICALLY** mounted **ABOVE** the highest priming point in suction piping.
2. Install 3/8" OD air hose piping from the Pressure Protected (PPV) air tank to the primer solenoid (See Figure #7).
3. Install the rocker switch electric primer control on pump panel (See Figure #8).
4. Install the pump pressure switch in a 1/4" NPT pressure opening on the top of the fire pump. Install switch in a vertical orientation and in a position that allows for proper drainage (See Figure #6).
5. Install the Automatic AirPrime wiring harness as follows: (See Page 7 and Figures 10, 11, 12)
 - 5a Gray 5-prong plug to rocker switch control in pump panel bezel, and connect 6" pigtail to wiring harness (gray plug).
 - 5b White wire to the **OK TO PUMP** light circuit or to fire pump shift control circuit (PTO or split shaft) (1-1/2 feet long) [.5 m].
 - 5c Red (+) and Black (-) wires to power supply (1 foot long) (Wiring and 1 amp fuse by installer).
 - 5d Plug in to AirPrime solenoid connection (5 feet of cable) [1.8 m].
 - 5e Plug in to fire pump discharge pressure switch (5 feet of cable) [1.8 m] (See Figure #6).



Figure 6

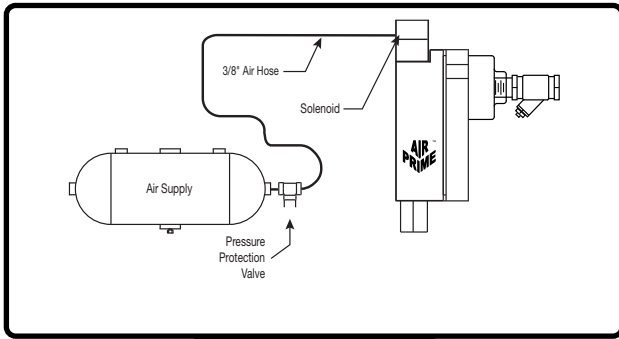

Figure 7

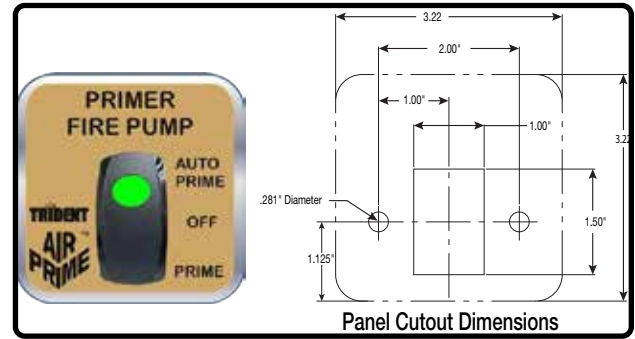

Figure 8

Operation: Automatic Priming Control

AUTO PRIME Mode (Top Position)

1. Normally, leave the AirPrime rocker switch in **AUTO PRIME** mode.
2. If drafting, connect all suction hoses, strainer, and tighten accordingly. Utilize wheel chocks. In cab: Apply parking brake, Engage pump per manufacturers recommendations (AirPrime will start priming automatically when the pump is engaged). **NOTE:** Never run a fire pump dry for more than 45 seconds.
3. Pump Panel: Verify that the green **OK TO PUMP** light is **ON** and then increase RPM. When the discharge pressure increases above 20 PSIG [1.4 Bar] the primer will disengage. When master gauge indicates greater than 20 PSIG [1.4 Bar] pressure, the discharges can be opened and pumping operations established.
4. Automatic Operation: If the pump prime is lost, AirPrime will automatically start and re-prime the fire pump. It will automatically turn off when the pump pressure reaches 20 PSIG [1.4 Bar].

OFF Mode (Center Position)

1. Disengages the AirPrime pump primer at all times.

PRIME Mode (Lower Position)

1. Push and Hold the momentary switch for manual engagement of the primer at any time.
2. For Operation: Properly engage the fire pump, verify that the green **OK TO PUMP** light is on, advance the throttle to 1000 RPM, push and hold the AirPrime momentary switch until pump is primed, open discharges slowly. Rocker switch can be changed to **AUTO** mode at any time.
3. The manual mode can be used without having the fire pump engaged for vacuum testing or training on the primer system.

Automatic Single Location AirPrime™ System with Optional Vacuum Gauge

Installation

1. Install AirPrime primer within pump enclosure. Unit must be **VERTICALLY** mounted **ABOVE** the highest priming point in suction piping.
2. Install 3/8" OD air hose piping from the PPV valve protected air tank to the primer.
3. Install the rocker switch electric primer control with lift gauge on the pump panel (See Figure #9).
4. Install the pump pressure switch in a 1/4" NPT pressure opening on the top of the fire pump (See Figure #6 on Page 6).
5. Install the Automatic AirPrime wiring harness as follows (See Figures 10, 11, 12):
 - 5a Gray 5-prong plug to rocker switch control in pump panel bezel, and connect 6" pigtail to wiring harness (gray plug).
 - 5b White wire to Hot (+) Side of **OK TO PUMP** light circuit or to fire pump shift control circuit (PTO or split shaft) (1.5 feet long) [5 m].
 - 5c Red (+) and Black (-) wires to power supply (1 foot long) (wiring and 1 amp fuse by installer).
 - 5d Plug in to AirPrime solenoid connection, 5 feet of cable [1.8 m].
 - 5e Plug in to fire pump discharge pressure switch, 5 feet of cable [1.8 m] (See Figure #6 on Page 6).
6. Connect a 1/4" OD [6.35 mm] tubing line (Not supplied) from the push-to-connect fitting supplied on the back of the panel lift gauge to the 1/8" NPT connection on side of the primer body using the 1/8" male NPT x 1/4" push-to-connect swivel elbow provided with the AirPrime unit. See photo below.

The lift gauge provides the following features:

- a) Indication of the vertical lift of water during priming operation.
- b) Lift gauge will not be damaged by positive water pressure supply line.
- c) Lift gauge can be used for positive periodic in-service ramp test without having the fire pump engaged.
- d) Operation is the same as Automatic AirPrime without a lift gauge.

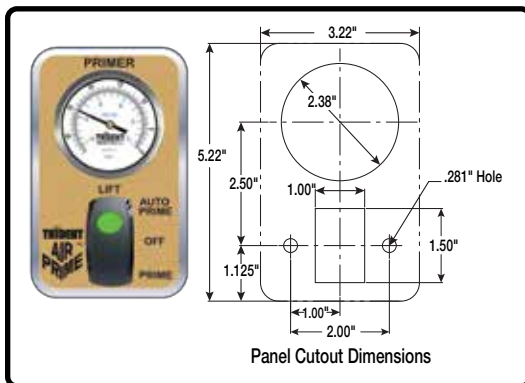
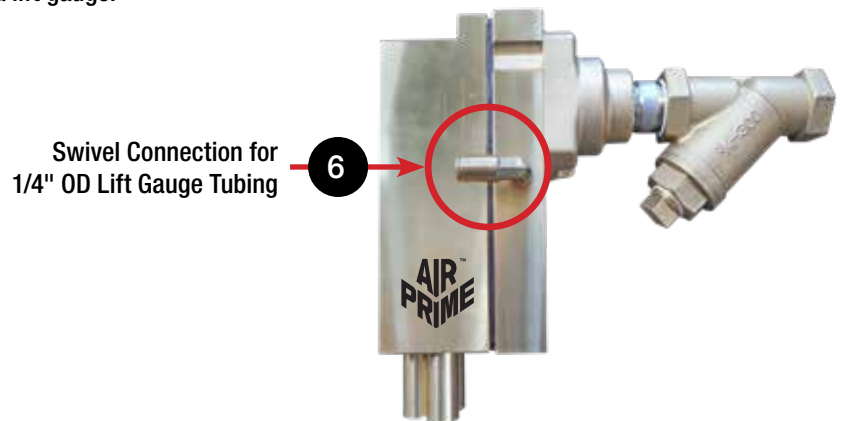

Figure 9



Wiring Harness
Part #41.001.2

Figure 10

Figure 11

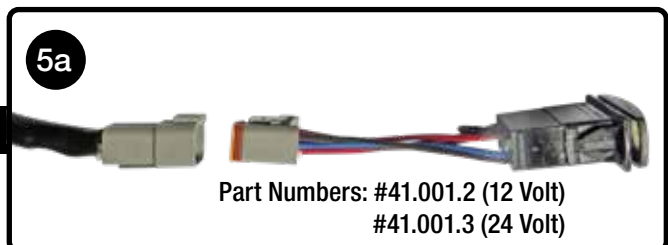
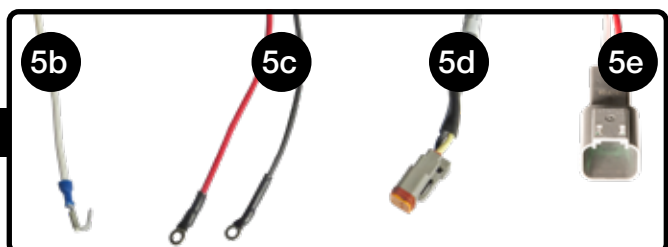

Figure 12



Manual Single Location AirPrime™ Systems

Installation

1. Install the AirPrime unit **VERTICALLY** within the pump enclosure. **Unit must be mounted ABOVE the highest point in suction piping.**
2. Install the manually operated primer push-to-operate air control on pump panel (see **Figure #13**).
3. Install 3/8" OD air hose piping with 1/4" NPT fittings from the PPV protected air tank to the primer manually operated push-to-operate control and then to the primer unit. (See **Figure #14**).
4. If the AirPrime is equipped with an optional lift gauge, connect a 1/4" tubing line from the push-to-connect fitting supplied on the back of the panel lift gauge to the 1/8" NPT connection on side of the primer body using the 1/8" male NPT x 1/4" push-to-connect swivel elbow provided with the AirPrime unit. (See **photo bottom right** for tubing connection location).

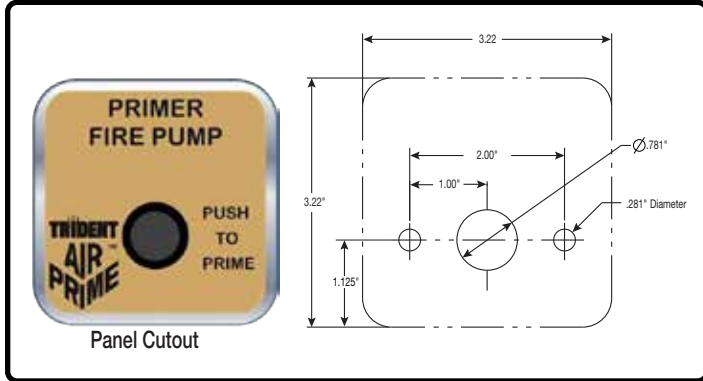

Figure 13

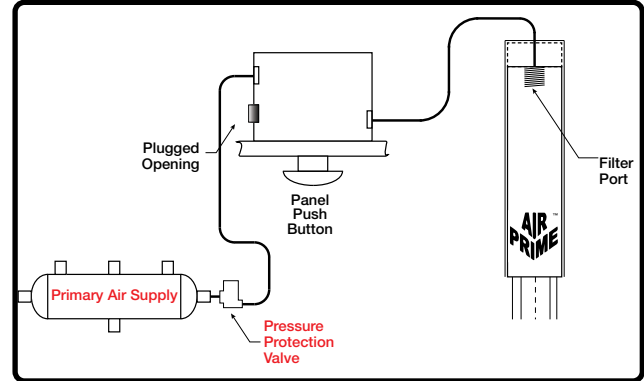

Figure 14

OPERATION: Manual Priming Control

The manual AirPrime pump primer is operated simply by increasing the engine speed to a maximum of 1000 RPM and depressing the push button on the panel. Hold the button down until the discharge pressure gauge begins to rise. The primer will stop running when the push button is released. The push button will operate the primer regardless of whether the fire pump is engaged or not.

1. Depressing the Push-To-Prime button directs air to the primer inlet.
2. An internal valve to the water pump is opened with air pressure from chassis air system.
3. Vacuum for drafting is created by air-flow through multi-stage internal venturi nozzles.
4. The Panel Control Valve has no water, plumbing or electrical lines.
5. Never run a dry pump at engine speeds above 1200 RPM for more than 45 seconds in accordance with fire pump manufacturer's operating instructions.

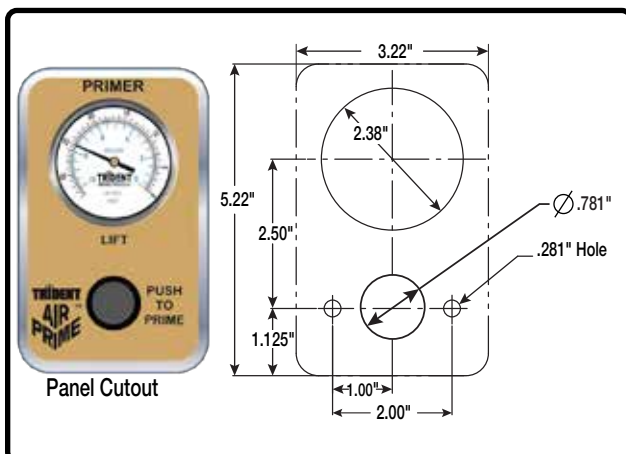
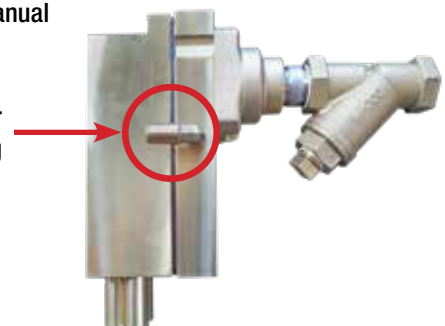

Figure 15

The lift gauge provides the following features:

- a) Visual indication of the vertical lift of water during priming operation.
- b) Lift gauge will not be damaged by positive water pressure supply line.
- c) Lift gauge can be used for positive periodic in-service ramp test without pump engagement.
- d) Operation is the same as a manual AirPrime without a lift gauge.

Swivel Connection for 1/4" OD Lift Gauge Tubing



Multi Location Installation and Operating Instructions

Key Points for All Installations

1. The AirPrime unit **MUST** be **VERTICALLY** mounted **ABOVE** the highest point in suction piping.
2. Remote Priming Valves **MUST** be mounted **ABOVE** the highest priming point in the suction plumbing.
3. If the RPV priming valve is mounted below the AirPrime unit, add drain lines from all low points to a drain valve to prevent freezing.
4. It is common to have up to four (4) remote locations with the AirPrime Multi-Location priming system.
5. If front suction pre-priming is required, refer to drawings on the bottom Pages 11 and 12 for installation recommendations.

Installation Notes for Multi-Location Priming Systems

1. Automatic System: Follow the instructions on Page 6 and Page 7 with lift gauge for mounting the first control on the pump panel.
2. Automatic System: Refer to schematics in Figure 17 on Page 11 for air lines, electric wiring and suction plumbing.
3. Automatic AirPrime Connections: See Figure 7 on Page 6 and information on Page 5.
4. Manual System: Follow the instructions on Page 8 for mounting the first control on the pump panel.
5. Manual System: Refer to schematics in Figure 16 on Page 10 for air lines, electric wiring, and suction plumbing.
6. For additional priming locations mount a push-button control as shown in Photo 5.
7. Gold labels are provided for LEFT, RIGHT, FRONT and REAR remote priming locations as shown in Photo 6.
8. See Photos 3 and 4 to note that the cast in arrows on the RPVs and Check Valves are in the proper direction of flow.

Operating Instructions for Multi-Location Automatic Priming System

1. See operating instructions for automatic priming system on Page 6 for the initial fire pump priming procedures.
2. Be sure the AirPrime switch is in the AUTOMATIC position when opening the remote location valve control.
3. To pre-prime a remote location, push the PRIME button of that location for 45 seconds or until water appears at top of hose.

Operating Instructions for Multi-Location Manual Priming System

1. See operating instructions for manual priming system on Page 8 for the initial fire pump priming procedures.
2. To pre-prime a remote location, push the manual button for that location for 45 seconds or until water appears at top of hose.
3. Be prepared to push the Fire Pump manual AirPrime Push-To-Prime button when remote location valve control is opened to remove any trapped air.

Multi-Location Components

1. Primer solenoid and Multi Location air inlets are shown below in Photos 1 and 2.
2. RPV Valve and Air Check Valve noted with directional arrows as shown below in Photos 3 and 4.
3. Additional pre-priming panel control and choice of appropriate labels shown in Photo 5 and 6.

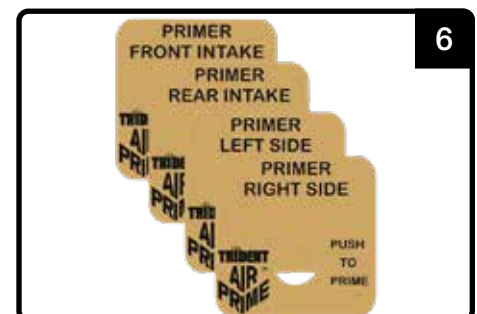
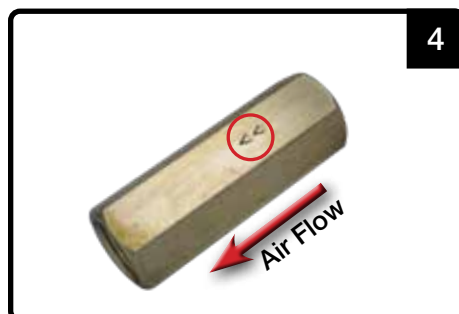
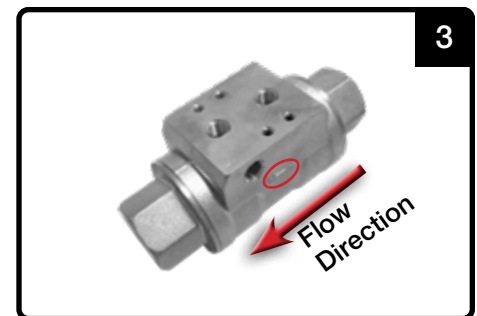
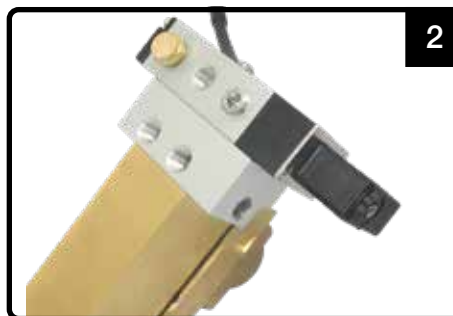
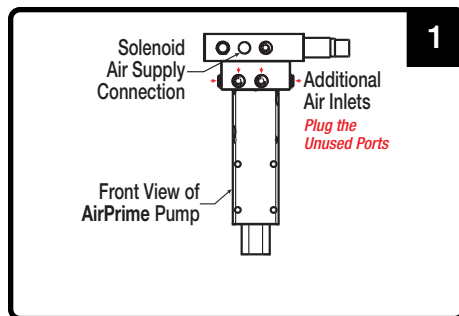

Multi Location Automatic AirPrime™ System Diagram

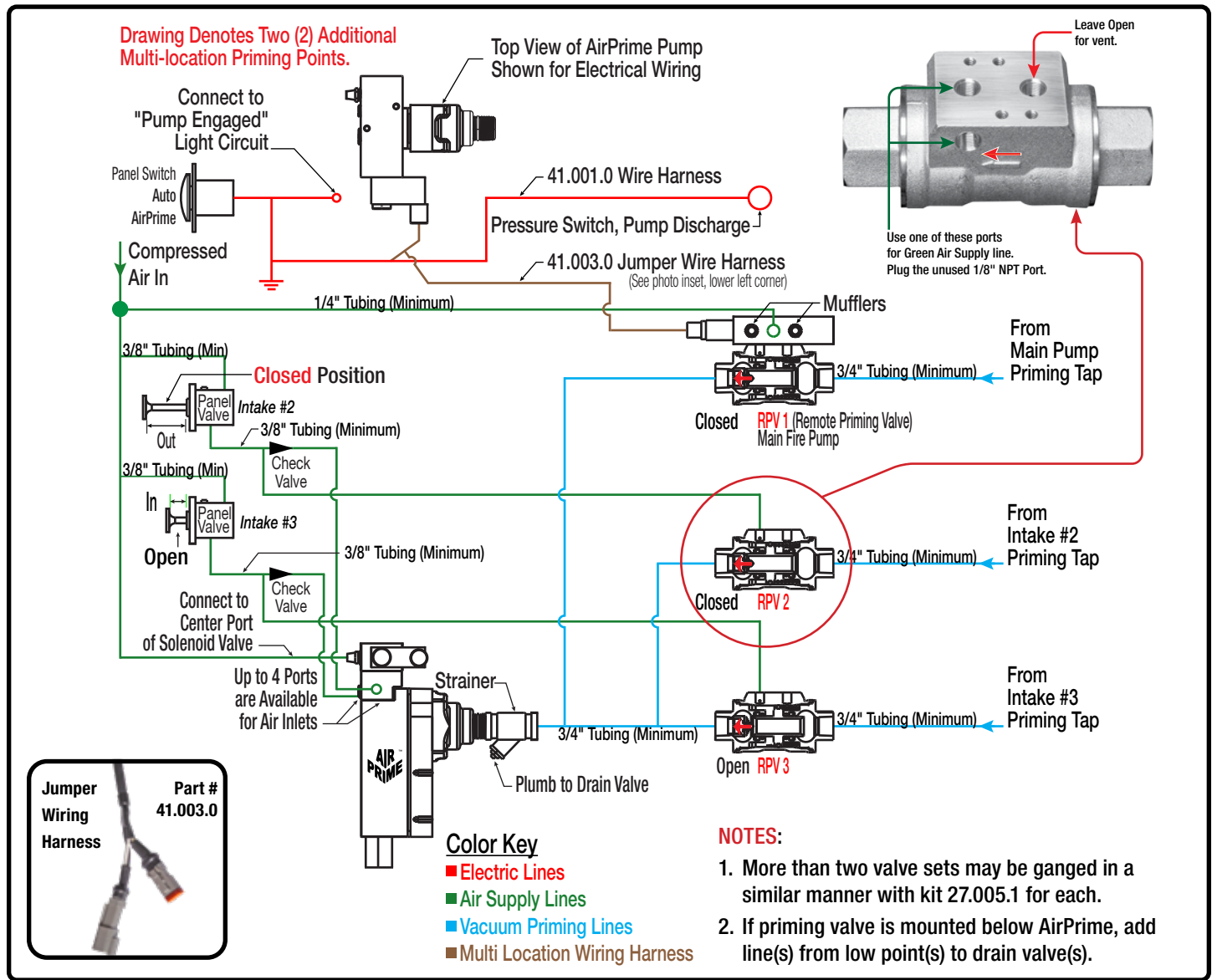
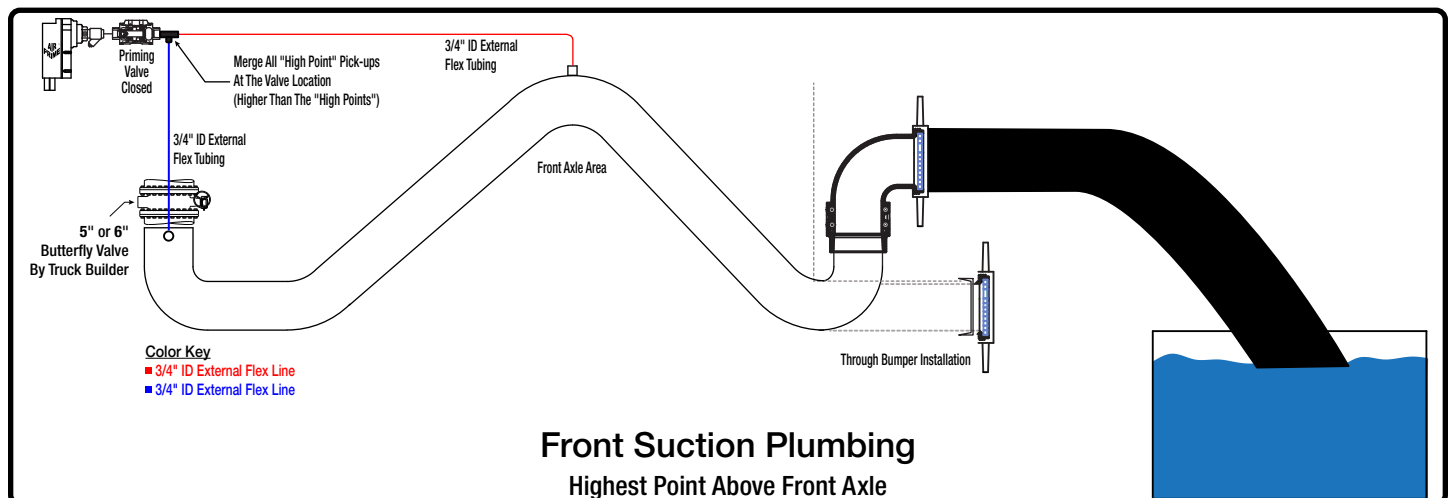

Figure 16



Multi Location Manual AirPrime™ System Diagram

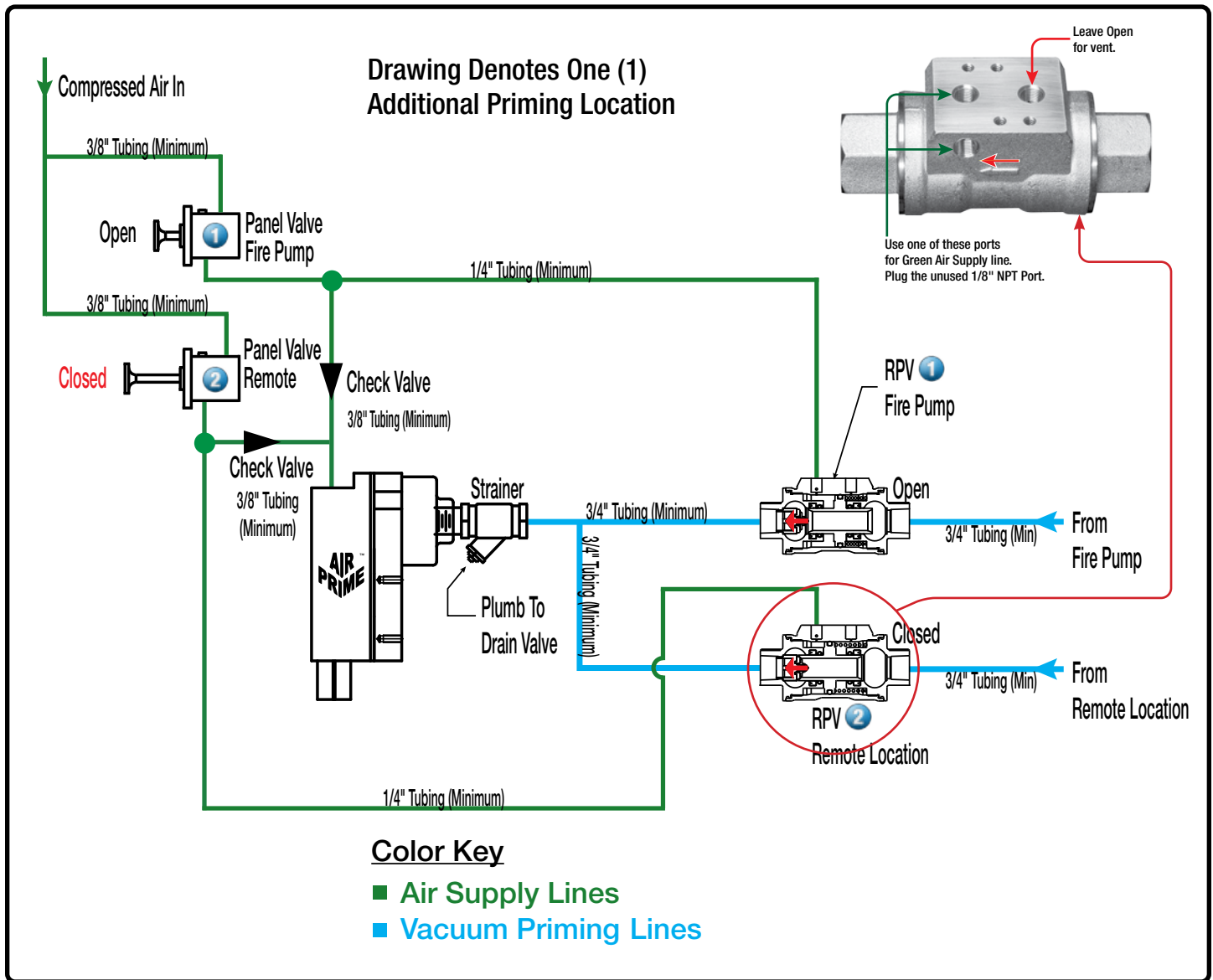
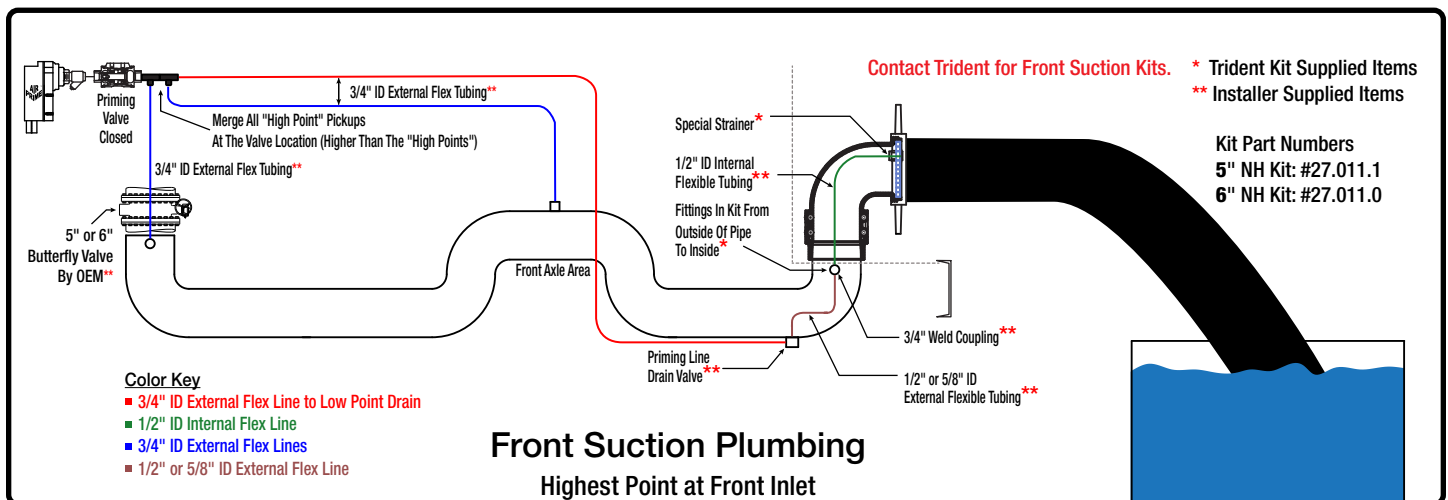

Figure 17



Trouble Shooting Guide

Problem	Likely Cause	Corrective Action
System Does Not Hold Vacuum.	<ul style="list-style-type: none"> • Master Drain Valve Open. • Discharge or Intake Valves Open. • Bleeder or Drain Valves Open. • Relief Valve Drain Open. 	Double check all drains, discharge and intake valves to make sure all are closed.
	Intake Relief Valve Allowing Air Into Pump System.	a) Adjust intake valve to closed position (be careful to count the number of turns to close and re-open the same number of turns). b) Cap the discharge side of the intake relief valve (NPT or NH). Be sure to remove cap after testing.
	AirPrime Exhaust Outlets Drawing Back Vacuum.	The integral priming valve is not closing all the way, air is moving upward into the barrels, into the pump, as the water falls back into the hard suction hose to the water level or as vacuum is lost through the fire pump system.
System Will Not Reach 22" Hg.	Inadequate air supply.	a) Check the CFM rating of the engine air compressor. See Page 4. b) Check air pressure at “supply” side of AirPrime (should be over 70-PSIG / [3.8 Bar]). Install a tee and air gauge in input for test purposes. If the air pressure is not the same as the cab dash air pressure gauge, check for under sized airline, kinks or obstructions in air line, or air line is too long (under 20 ft [6 m] from primary tank.
	Pressure Protection Valve.	Check Pressure Protection Valve air on/off settings (should shut-off in the 60 to 80-PSIG / [4.2 to 5.5 Bar] range) and OPEN no higher than 80-PSIG / [5.5 Bar] to AirPrime.
	Air filter on intake side of air supply connection to <i>AirPrime</i> body. <i>For details on filter inspection/replacement visit/click QR codes at right.</i>	a) Manual AirPrime: Remove air supply piping, remove fine mesh filter, clean or replace. Part#: 21.002.0 b) Automatic AirPrime: Remove air supply piping, remove air solenoid assembly, remove fine mesh filter, clean or replace. Part #: 21.002.0
	Slight air leak in discharge or intake valves in fire pump plumbing.	Hydrostatic test the plumbing system to NFPA #1901 standard with wet fire pump and closed valves: 250-PSIG [17.2 Bar] for 10 minutes w/ pressure loss.
	Check the interior check valves inside the primer.	Remove and disassemble primer to inspect the (3) small rubber check valves to venturi orifices.
	Check the interior primer body venturi nozzles for foreign material or blockage.	Remove and disassemble primer to inspect venturi nozzle openings or clean with small wire to assure open orifices.
	Defective Primer.	Replace or rebuild primer with Kit #27.003.3. See Instructions Here ►
<i>AirPrime</i> Leaks Water.	Check the <i>AirPrime</i> integral priming valve.	a) The priming valve is not seating in the shut-off position: Remove primer, disassemble, and check the priming valve spring, seat and operation. b) The priming valve is “stuck”, check for damaged O-Ring or check to see if piston is fully threaded on the valve stem.
<u>Manual System:</u> Air continues to flow when button is released.	Bad push button manual valve.	Replace the Push Button with a new valve, Part #27.003.1.
	Push button air plumbing installed incorrectly.	Refer to air schematic drawing, Figure 14 on Page #8 of this manual.
<u>Automatic System:</u> Air continues to flow when button is released.	Panel switch inoperable.	Refer to parts list on Page 16, order replacement switch, Part #27.003.2.
	Air solenoid on top of primer is defective.	Refer to parts list, order replacement solenoid, Part #30.003.0 (12 Volt) or #30.003.1 (24 Volt).
	Solenoid is on backwards.	Reverse orientation of solenoid on top of manifold. Ports on solenoid and manifold should be on the same side.

Filter Info

Manual

Filter Info

Auto

Kit 27.003.3

Instructions

Visit www.TridentAutoAirPrime.com for additional AirPrime information.

Trouble Shooting Guide (Continued)

Problem	Likely Cause	Corrective Action
Slow Prime Time.	Leaking air into the plumbing system.	Double check all drains, discharge, and intake valves to make sure all are closed.
	Low air pressure.	Check air pressure at supply side of AirPrime (Should be over 70-PSIG/[3.8 Bar]). Install a tee and air gauge in input for test purposes. If the air pressure is not the same as the cab dash air pressure gauge, check for an under sized airline, kinks or obstructions in air line. Or the air line may be too long (Must be under 20 feet [6 m] from primary tank).
	Pressure Protection Valve.	Check Pressure Protection Valve air on/off settings (should shut-off in 60 to 80-PSIG / [4.2 to 5.5 Bar] range) and OPEN no higher than 80-PSIG / [5.5 Bar] to AirPrime.
	Check wye strainer on intake from fire pump, could be clogged.	Remote primer installation: The line from the fire pump to the AirPrime has a wye type strainer just before connecting into the primer body. Remove the plug, then strainer, and clean the strainer of debris, reinstall strainer and plug. a) Direct mount on Hale pump installation: Remove the primer from the Hale Q fire pump, check the black plastic strainer (Supplied by Hale).
	Check Air line to the AirPrime.	The air supply line from the air tank is either kinked, undersized or over length. Replace air line accordingly (NOTE: Found mainly on new installations).
	Check discharge and intake valves.	Cap or plug the discharge and intake valves to prove the valves are not leaking air into the plumbing system (Hydrostatic pump test is useful for such testing).
	Check gated Master Intake Valves on suction intakes.	a) Remove the MIV and cap intake. b) Install a cap on the discharge side of the relief valve. c) Cap the Storz or NH intake.
	Check the AirPrime integral priming valve.	a) The priming valve is not seating in the shut-off position, remove primer, disassemble, and check the priming valve spring, seat, and operation. b) The priming valve is “stuck”, check for damaged O-Ring or check to see that the piston is still fully threaded on the valve stem.
	Suction lift too high.	Do not attempt lifts exceeding 24 feet.
	Blocked suction strainer.	Remove any obstructions or debris from hose strainer, do not allow suction hose or strainer to rest on the bottom of water supply.
	Leaking Suction Hose connections.	Clean and tighten all suction hose connections, check hose washers and replace as necessary.
Air Trap in suction line.	Suction hose should be positioned with a constant decline to the water supply. If a trap is unavoidable, repeated priming may be required to eliminate air pocket.	
Multi Location Specific		
Problem	Likely Cause	Corrective Action
Trouble Priming or Pre-Priming from Locations Other Than Pump.	Not priming from highest suction plumbing point.	Check suction plumbing elevations, shown on bottom of Pages 10 and 11. Check for changes in suction high point when truck is drafting on an incline.
	Remote Priming Valve (RPV) not opening.	Defective RPV, defective panel push button, check system plumbing using schematics on Page 10 (Automatic) Figure 16 and Page 11 (Manual) Figure 17.
	Water trap in RPV line.	Lines must ascend from highest suction plumbing points to RPV(s) for natural drainage and to avoid water traps.

AirPrime™ Industrial and SC Systems

AirPrime units are available for high volume Industrial Pumpers/Trailers with engine driven air compressors and small Wildland Trucks without air brakes. Contact Trident for more information.

Annual Primer Testing

The AirPrime™ primer is designed to meet the NFPA requirements of: **Dry Vacuum (TEST #1)** and **Priming Time (TEST #2)**. These tests should be performed on an annual basis, or whenever major repairs or modifications have been made to the fire pump, plumbing or primer.

TEST #1 Dry Vacuum Test: Checks the primer's ability to produce 22 inches (Hg) [745 Bar] of vacuum, and the pump and plumbing's ability to hold that vacuum. The test may be run with the pump in gear or not engaged. Never run a dry pump at engine speeds above 1200 RPM. There is no time requirement for the vacuum to reach 22 inches. If the compressor has a capacity of 13.2 CFM [374 cu. cm. displacement], it can take several minutes to reach 22 inches [75 Bar]. This time can be shortened by not engaging the pump and increasing the engine speed to 1200 RPM. The test process is as follows:

1. Drain all water from pump and plumbing.
2. Close all valves and drains. Cap all suction openings and the outlet off of the suction side relief valve (if so equipped).
3. Connect a test vacuum gauge to the intake test gauge connection on the pump panel.
4. Operate the AirPrime with the air system at over 100 PSIG [7.0 Bar] pressure, air tanks filled to capacity, and at 1000 RPM engine speed; until the vacuum gauge indicates 22 inches (Hg) [75 Bar] or more of vacuum. (If the primer is an **Automatic AirPrime**, use the **PRIME** mode switch position to engage the primer).
5. Watch the gauge, if the vacuum falls more than 10 inches in 5 minutes the test has failed and is a certain indication of an air leak(s). Vacuum leaks may be detected by ear, with the engine turned off. Correct leaks immediately and test the priming system again.

TEST #2 Priming Time Test: This test is to prove that the fire pump and primer has the capability of attain a prime and creating discharge water pressure in a set period of time. This test is also conducted by the apparatus builder prior to delivery. The fire pump shall be engaged and primer actuated. The test is part of an annual pump performance test and is performed as follows:

1. Set up the apparatus in accordance with the pumping test outlined in the NFPA standards.
2. Engage the pump, and increase the throttle to a maximum engine speed of 1000 RPM.
3. Operate the AirPrime with the air system at over 100 PSIG [7.0 Bar] pressure, air tanks filled to capacity, and at 1000 RPM engine speed.
 - For the **Manual** controlled primer, release the push button when a discharge pressure over 20 PSIG [1.4 Bar] is obtained.
 - For the **Automatic AirPrime**, place the switch in the **AUTO** position, it will turn the primer off automatically when priming is attained.
4. The time to prime should not exceed 30 seconds for 1250 GPM [4700 LPM] and smaller pumps. The time to prime should not exceed 45 seconds for 1500 GPM [5600 LPM] and larger pumps. An additional 15 seconds is allowed for pumps with auxiliary suctions using 4" or larger piping.

Higher lifts and operating at higher elevations will slow down time to prime. The air compressor rating should be a minimum of 18 CFM [410 cu. cm. displacement] for elevations over 4000 feet [1200 m] and lifts in excess of 15 feet [4.5 m]. Operation at these extremes may require the primer to be operated at engine speeds in excess of 1000 RPM without engaging the pump, until water reaches the impeller. Never run a dry pump at engine speeds above 1200 RPM.

IN-SERVICE OPERATIONAL TEST (Ramp Test)

The integrity and operation can be quickly checked (on a daily or weekly basis) as outlined below, without fire pump engagement:

1. Drain all water from pump and plumbing.
2. Close all valves and drains. Cap all suction openings.
 - Operate the AirPrime with the air system at over 100 PSIG [7.0 Bar] pressure, air tanks filled to capacity, and the engine running at 1000 RPM (with an Automatic AirPrime electrically controlled model, use the **PRIME** mode switch position).
3. Stop running the primer.

Time to reach 15 inches HG [50 Bar] or 17 feet [5.0 m] on lift gauge should be within the time allowed in list below for the pump tested.

Small Body Pump (Up To 1250 GPM): Vacuum Time

10 inches HG [.33 Bar] (11 feet) 6 Seconds

15 inches HG [.50 Bar] (17 feet) 15 Seconds

Large Body Pump (Over 1250 GPM): Vacuum Time

10 inches HG [.33 Bar] (11 feet) 8 Seconds

15 inches HG [.50 Bar] (17 feet) 20 Seconds

Note: Vacuum Time listed in the table at left are for operations up to 2000 feet [609 m] of elevation. When running this In-Service Operational Ramp Test at higher elevations, the vacuum should be reduced by 1 inch (1.13 feet) for each 1000 feet [304 m] of elevation over 2000 feet [609 m].

Warranty and Product Information

5 Year Warranty

For five years after the date of purchase, Trident Emergency Products, LLC warrants its products to be free from defects in materials and workmanship when properly installed, operated, and maintained.



If during the warranty period, a product is discovered to be defective, Trident will, at its option, replace or repair the warranted product or grant the purchaser a credit for the product claimed to be defective. Trident will have the sole discretion to determine whether the product was defective.

This warranty is null and void if the product is damaged due to abuse, misuse, negligence or accidental causes.

No warranty of merchantability or fitness for a particular purpose, nor any warranty, express or implied, is made by Trident. The foregoing states Trident Emergency Products, LLC's entire and exclusive liability and buyer's exclusive remedy for any claim or damages in connection with the sale of its products. In no event shall Trident be liable for any special incidental, or consequential damages whatsoever.



Ordering

Please use Trident part numbers and descriptions when placing orders. All orders must be written, **E-Mail** (sales@tridentdirect.com) or **Fax** to (215) 293-0701 or placed online at www.tridentdirect.com. All orders will be acknowledged by Trident within 2-days and shall become final after acknowledgment, if not challenged.

No verbal orders will be accepted.



Terms

1%10-NET30 days on approved credit, or with MC/Visa credit card. Service charge 1.5% on past due accounts.

Freight

F.O.B. Hatboro, PA, USA. Our responsibility ceases upon delivery to common carrier. Consignee must file claim for storage and damaged freight with the carrier.

Delivery

Most standard items are shipped in five business days or less. Consult with customer service for availability, special threads, or special order products.

Return Policy

No material will be accepted for return without authorization by the factory, and a return goods authorization number assigned. Materials must be returned prepaid. A 20% restocking fee normally applies. No material will be accepted for a credit after one year from the date of purchase.

Custom products and special orders are not returnable.



Safety First!!!

Serious Injury and Destruction of Property can result from improper selection or improper use of products described in this instruction manual. Since TRIDENT has no control over the number and variety of applications for which its products may be purchased or the conditions under which they may be used, TRIDENT liability on any claim, whether in contract, tort (including negligence), or otherwise, for any loss or damage shall in no case exceed the price paid for the product or any part thereof which give rise to claim. As always, TRIDENT technical assistance and support is available for your convenience.



Warning - User Responsibilities

The customer, installer and end-user shall assume sole responsibility in making the final selection of products and accessories. Furthermore, these parties shall hold TRIDENT harmless for all liability, claims, suits and expenses incurred. These parties shall ensure maintenance, safety precautions and warnings regarding the application are enforced at all times. TRIDENT is not responsible for use of products in excess of rated and recommended capacities, design functions or abnormal conditions.



Caution - Proper Selection of Accessories

TRIDENT offers a wide variety of accessory items and optional features for its products. It is the sole responsibility of the customer, installer and end users to ensure that the proper items and features have been selected to fit the application.



Warning - Follow Instructions

The customer, installer, and end users shall ensure that all potential users of these products receive continual training and access to all relevant product manuals and safety instructions. This information should be thoroughly reviewed prior to installation, stored and reviewed continually during use of the product. TRIDENT assumes no responsibility for fitness of installation and continued use in specific applications.



Customer Service Phone (215) 293-0700

We pride ourselves with exceptional customer service and are available to answer questions pertaining to new or existing orders and any of your after the sale support concerns. If a product needs to be returned, please call and request a Returned Goods Authorization (RGA) number. Warranty claims must be made by an authorized TRIDENT employee. Be prepared to provide the product model number and purchase invoice number. Replacement parts ordered will be invoiced to your account. Once an RGA number is received, you must write it on all boxes and paperwork. TRIDENT will not accept your returned goods without an RGA number. Upon receiving the return, if it is determined to be covered under warranty, a credit memo will be issued and mailed to you for your records.



Note: All designs, specifications, and dimensional data contained in this catalog are subject to change without notice. No additional warranties, express or implied, including warranties of merchantability for fitness for a particular purpose, are created by the descriptions and depictions of the products on or in this catalog. Not responsible for typographical errors.

Repair/Replacement Parts

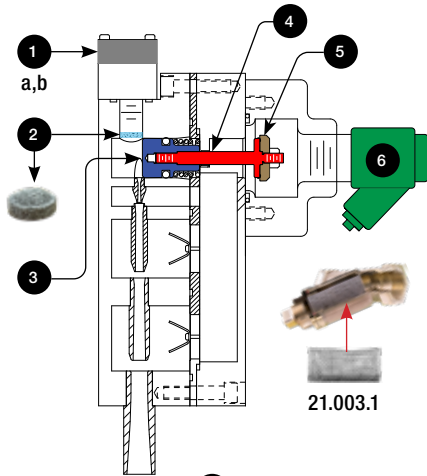

21.003.1

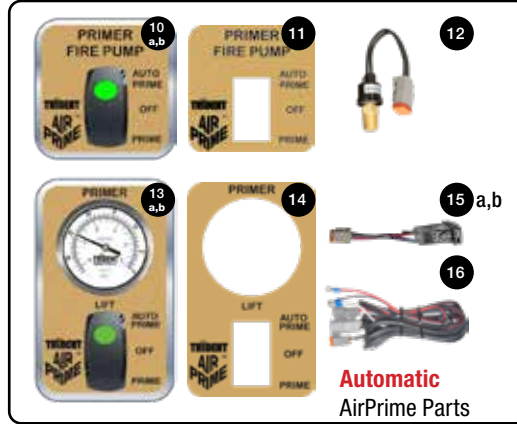

Automatic
AirPrime Parts

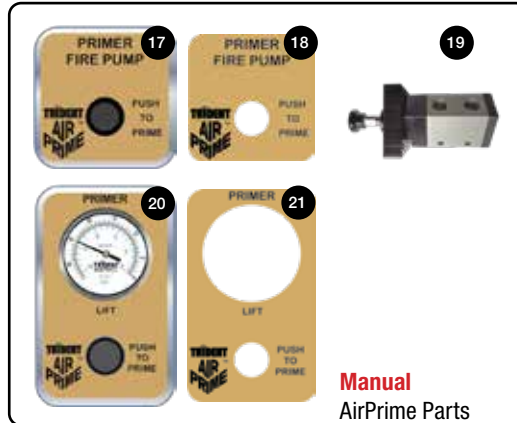

Manual
AirPrime Parts

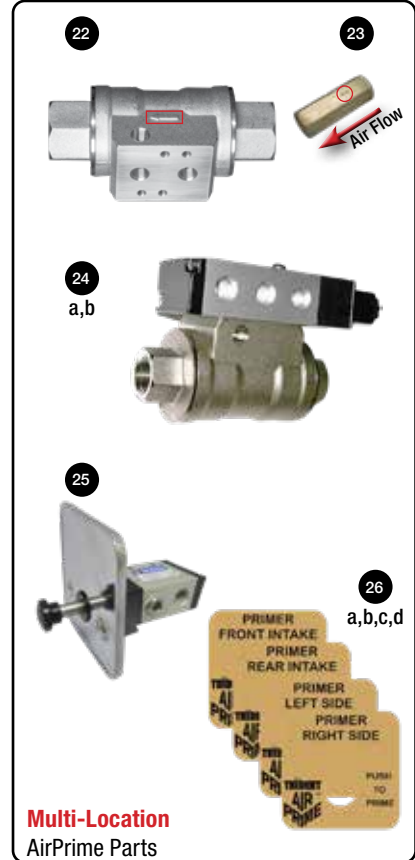

Multi-Location
AirPrime Parts

REF #	DESCRIPTION	PART #
1a	Solenoid Valve <u>12-Volt</u>	30.003.2
1b	Solenoid Valve <u>24-Volt</u>	30.003.3
2	Air Filter Replacement for 1/4" NPT Bore	21.002.0
3	Piston	11.001.0
4	Valve Stem	05.002.0
5	Seal Washer	04.004.0
6	3/4" Wye Strainer (Replacement Screen: 21.003.1)	21.003.0
7	Rebuild Kit (Seals, Mesh Filter, Spring Valve Plate, Fasteners)	27.003.3
8	Pressure Protection Valve (PPV)	30.053.0
9	Lift Gauge	14.006.0
10a	Rocker Switch <u>12-Volt</u> and Label Assembly	27.003.5
10b	Rocker Switch <u>24-Volt</u> and Label Assembly	27.003.6
11	Label Only: <u>Rocker Switch</u>	02.004.2
12	Pressure Switch and Connector	40.002.1
13a	Rocker Switch <u>12-Volt</u> , Label, Mounting Plate, Lift Gauge Assembly	27.003.7
13b	Rocker Switch <u>24-Volt</u> , Label, Mounting Plate, Lift Gauge Assembly	27.003.8
14	Label Only: <u>Rocker Switch with Lift Gauge</u>	02.004.4

REF #	DESCRIPTION	PART #
15a	Rocker Switch <u>12-Volt</u> Replacement	40.001.2
15b	Rocker Switch <u>24-Volt</u> Replacement	40.001.3
16	Wiring Harness for Auto AirPrime	41.001.0
17	Push Button, Label, and Mounting Plate Assembly	27.003.1
18	Label Only: <u>Push Button</u>	02.006.4
19	Push Button Replacement	30.005.3
20	Push Button, Label, Mounting Plate and Lift Gauge Assembly	30.005.4
21	Label Only: <u>Push Button with Lift Gauge</u>	02.006.10
22	Remote Priming Valve (RPV)	30.035.1
23	1/4" NPT Air Check Valve	30.012.0
24a	Remote Priming Valve with <u>12-Volt</u> Solenoid	30.035.10
24b	Remote Priming Valve with <u>24-Volt</u> Solenoid	30.035.11
25	Multi-Location Push-Button w/ Mounting Plate	27.003.9
26a	Label Only: <u>Primer Front Intake</u>	02.006.5
26b	Label Only: <u>Primer Rear Intake</u>	02.006.6
26c	Label Only: <u>Primer Left Side</u>	02.006.7
26d	Label Only: <u>Primer Right Side</u>	02.006.8

AirPrime Conversion Kits and Rebuild Kit

Conversion Kit: Single Location AirPrime System, Converts Manual to Automatic	27.014.0
Conversion Kit: Multi-Location AirPrime System, Converts Manual to Automatic	27.014.1
Conversion Kit: Manual AirPrime System, Converts Single (1) Location to Dual (2) Location	27.005.2
Conversion Kit: Automatic AirPrime System, Converts Single (1) Location to Dual (2) Location	27.005.3
Conversion Kit: Multi-Location AirPrime System, Adds Additional Locations Going From (2) Location to (3) Location. <i>Or From (3) Location to (4) Location</i>	27.005.1
Conversion Kit: Automatic AirPrime System, Adding a Lift Gauge to existing Automatic AirPrime. Requires .125" NPT Port. Contact Factory for Details	27.005.5
Conversion Kit: Manual AirPrime System, Adding a Lift Gauge to existing Manual AirPrime. Requires .125" NPT Port. Contact Factory for Details	27.005.4
Conversion Kit: Manual AirPrime, Converting to Auto with Lift Gauge. Requires .125" NPT Port. Contact Factory for Details	27.005.6
Rebuild Kit: Contains Seals, O-Rings, Spring Valve Plate, Domed Inlet Filter and Fasteners	27.003.3



Trident Emergency Products, LLC

2940 Turnpike Drive | Suite #9 | Hatboro, PA 19040 USA
 215-293-0700 Phone
 215-293-0701 Fax
 sales@tridentdirect.com Email

TridentDirect.com

#02.003.1e • 06/25/2019



<https://www.facebook.com/tridentemergency>



World Class
Fire Industry
Products

AirPrime™ is a trademark of
Trident Emergency Products, LLC