

FOAMATE™ 2.1

Technical Manual

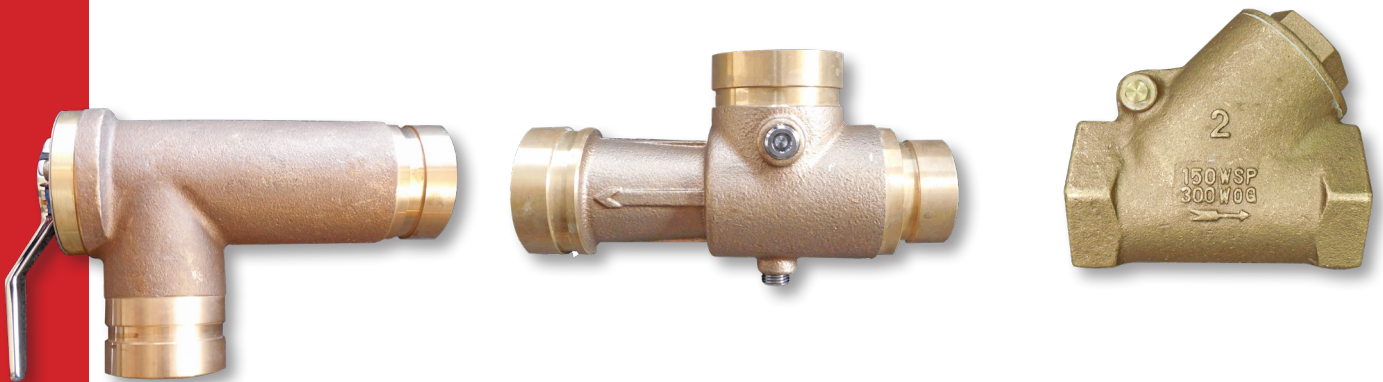
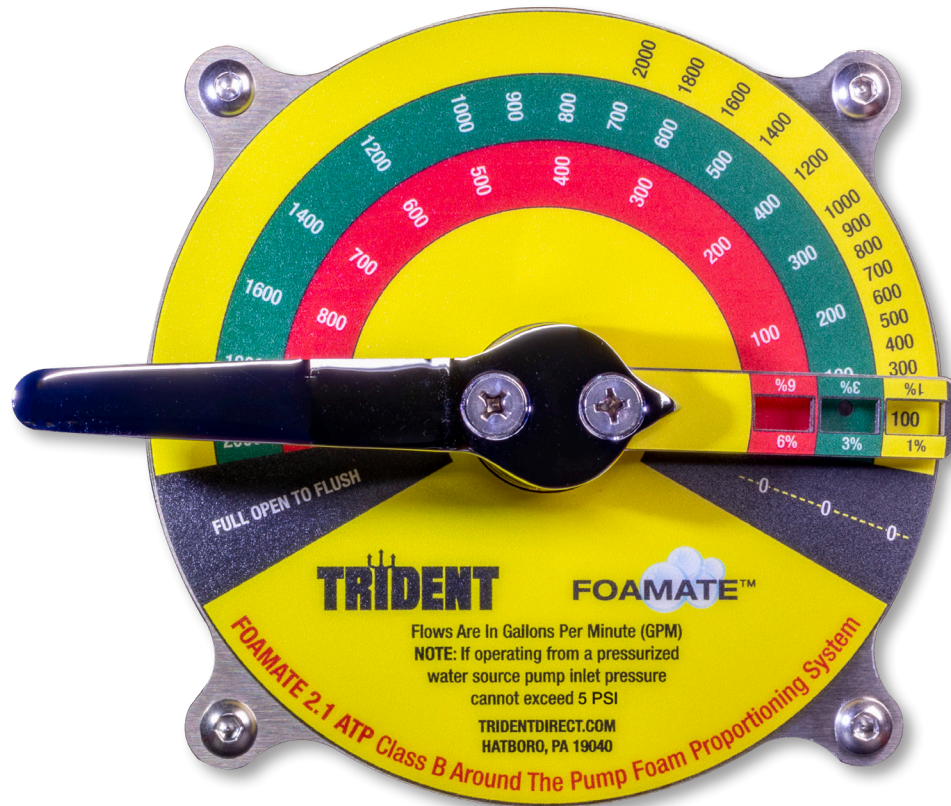

World Class Fire Industry Products

Contents

Maximum System Flow Rates:.....2

Foamate 2.1 General Information.....2

Performance and Operating Parameters2

Installation Instructions3

Foam System Operating Procedures from On-Board Foam Tank4

Foam System Operating Procedures from External Auxiliary Foam Concentrate Source.....4

General Operating Tips for ATP Foam Systems.....4

Foam System Shutdown Instructions4

Foam System Flushing Instructions4

Schematic/Instruction Plate Template.....5

Metering Valve/Dial Template5

Piping Schematic6

Benefits of an External Pickup Tube - Enhancing Your Foam System.....7

Model Numbers and Parts Listing.....8

Metering Valve Details.....9

Foam System Maintenance.....10

Foamate 2.1 Rebuild Kit.....10

Installation Notes.....11

Operating Notes11

Other Foam System Products.....12

Maximum System Flow Rates:

- 1% Injection: 2000 GPM [8000 LPM]
- 3% Injection: 2000 GPM [8000 LPM]
- 6% Injection: 1000 GPM [4000 LPM]

Foamate 2.1 General Information

Trident's FOAMATE™ 2.1 ATP is an around-the-pump foam proportioning system that adds fast and easy to operate **Class B** foam capabilities to any fire apparatus. The system utilizes a brass eductor installed on the discharge side of the fire pump to send a small volume of water back to the suction side of the fire pump. The venturi action of the eductor creates a vacuum at the foam concentrate inlet allowing foam to be pulled through the metering valve, into the water stream. The foam solution is discharged back to the suction side of the fire pump and sent through all the discharge piping – allowing foam solution to be available for each discharge outlet. The brass metering valve allows for injection rates of 1%, 3% and 6% at variable flow rates and pressures. Units are available in either GPM or LPM flow designations and are configured with either Victaulic™ or FNPT connections. **NOTE:** Throughout this document, Victaulic ends are referred to as VIC.

Performance and Operating Parameters

-
- ▶ **Eductor:** All brass construction. 1½" [38 mm] water inlet, 2" [50 mm] foam concentrate inlet, 2" [50 mm] foam solution outlet. All connections are pipe groove Victaulic.
 - ▶ **Eductor Flow:** 85 GPM [320 LPM] at 125 PSI [8.5 Bar].
 - ▶ **System Operating Pressure:** 125 – 250 PSI [8.5 – 17 Bar].
 - ▶ **Flow Rates:** Variable flow rates to multiple discharge outlets up to the maximum foam system capacity.
 - ▶ **Factory calibrated.** Meets NFPA Standards.
 - ▶ **Metering Valve:** All brass construction. 2" [50 mm] pipe groove Victaulic or FNPT foam concentrate inlet and outlet.
 - ▶ All discharge outlets provide foam solution at the same time.
 - ▶ No back pressure restriction from hose lengths or elevation.
 - ▶ Compatible with any type of foam concentrate and foam making nozzle.
 - ▶ Fire pump operations do not change.
 - ▶ Maximum fire pump inlet pressure: 5 PSI [0.35 Bar].

Installation Instructions

Eductor (Please refer to the Plumbing Diagram, Figure 4 on Page 6)

Mount the eductor in a 2" [50 mm] diameter line from the discharge side of the fire pump with a 2" [50 mm] ball shut-off valve upstream of the eductor. The discharge side of the eductor is plumbed with 2" [50 mm] piping back to the suction side of the fire pump. Observe the flow direction arrow on the eductor for proper placement.

Foam Concentrate Metering Valve

A 2" metering valve can be mounted to an enclosed pump panel or directly into the piping with access to the pump operator. If mounted to an enclosed pump panel, piping connections to the valve must be properly supported – see valve mounting hole pattern Figure 3 on Page 5. Supply the inlet side of the metering valve with 2" [50 mm] plumbing from the foam concentrate tank. This line must include a 2" [50 mm] foam tank ball shut-off valve. 2" [50 mm] plumbing connects the discharge side of the metering valve to the eductor. Details of the metering valve internals are shown Figure 5 on Page 9. **This Line Must Include a 2" [50 mm] Check Valve (supplied with the kit) to prevent back flow of water to the foam concentrate tank.**

NOTE: The swing check valve must be mounted in a horizontal position and in the correct direction for proper operation.

External Foam Concentrate Connection

A 2" [50 mm] valved hose connection can be provided at the pump panel to allow an external foam concentrate supply from drums, pails, etc. See Page 7 for optional auxiliary foam concentrate pickup hose and pickup tubes.

Flushing Piping

Piping of 2" [50 mm] diameter is to be installed between the water inlet connection of the eductor and foam concentrate inlet of the metering valve as a means to flush both the metering valve and eductor after each use. This plumbing must include a 2" [50 mm] ball shut-off valve.

Schematic/Instruction Chart

A backing plate is supplied for the schematic/instruction plate and must be mounted in close proximity to the foam metering valve.

Refer to Figure 2 on Page 5 for the mounting hole dimensions.

Plumbing Requirements

- ▶ **NOTE:** The design of the Metering Valve and Eductor are not intended to support the weight of the 2" [50 mm] plumbing. Piping to and from the Eductor and Foam Metering Valve must be properly supported.
- ▶ Foam metering valve and all of the 2" [50 mm] ball shut-off valves in the system must be accessible to the pump operator.
- ▶ Refer to Figure 3 on Page 5 for the mounting hole dimensions for the Metering Valve Backing Plate.
- ▶ Observe that the cast in arrows in the red rectangles in Figure 1 on the Check Valve and Eductor are installed in the manner as shown in the plumbing diagram Figure 4 on Page 6.
- ▶ The eductor features two (2) ¼" NPT [6 mm] pipe plugs shown in the red circles in Figure 1 for use as drain points based on the orientation of the eductor. All other plumbing connections on the eductor are VIC pipe grooved ends.

Plumbing Recommendations (Also Refer to top of Page 7)

- ▶ Install a valved direct water tank fill line to keep the on-board water tank filled from hydrant or nurse tanker. With this feature the foam system can be used continuously from the on-board water tank greatly simplifying the 5 PSIG [0.35 BAR] inlet pump pressure restriction.
- ▶ Install a valved external auxiliary foam inlet connection at the pump panel to supplement the on-board foam tank. With this feature, using a pick-up tube, a different type of foam concentrate can be used from that of the on-board tank. It also eliminates the need to fill the on board foam cell during an extended operation by supplying foam concentrate directly from containers on the ground. Also, with this auxiliary foam inlet and pick-up tube, foam system training can be done simply utilizing a container on the ground filled with water; operators can see how the system draws water based on different metering valve settings.

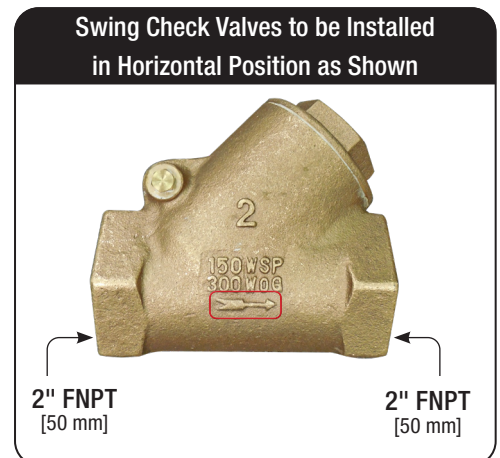

▲Figure 1▼

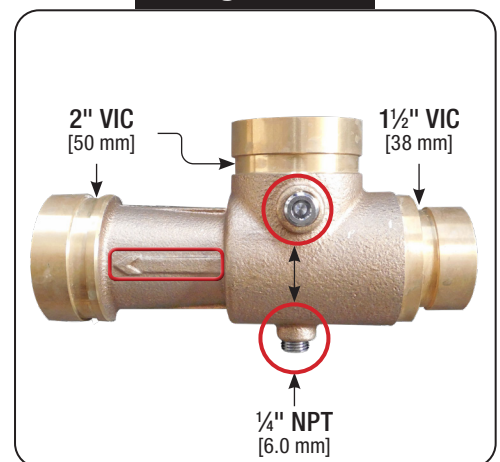

Foam System Operating Procedures from On-Board Foam Tank

1. Engage fire pump and establish water flow based on standard apparatus operating procedures.
2. Open 2" [50 mm] water supply valve to eductor.
3. Determine discharge GPM/LPM flow rate and open the foam metering valve to desired setting per the flow/injection dial.
4. Open 2" [50 mm] foam concentrate tank supply valve to metering valve.
5. The 2" [50 mm] system flush valve must be closed.
6. If an external auxiliary foam concentrate connection is provided, the inlet valve from this connection **must be closed**.

NOTE: The foam system will work properly from draft or the on-board water tank. If operating from a pressurized water source (hydrant or relay pumper) maximum fire pump inlet pressure cannot exceed 5 PSI [0.35 BAR] for proper foam system operation. In the event of high fire pump inlet pressure, install a direct water tank fill connection and operate the foam system using the on-board water tank.

Foam System Operating Procedures from External Auxiliary Foam Concentrate Source

1. Engage fire pump and establish water flow based on standard apparatus operating procedures.
2. Open 2" [50 mm] water supply valve to eductor.
3. Determine discharge GPM/LPM flow rate and open the foam metering valve to desired setting per the flow/injection dial.
4. If apparatus is equipped with an on-board foam tank, the supply valve must be closed.
5. The 2" [50 mm] system flush valve must be closed.
6. Open 2" [50 mm] external auxiliary foam concentrate inlet valve.

NOTE: The foam system will work properly from draft or the on-board water tank. If operating from a pressurized water source (hydrant or relay pumper) maximum fire pump inlet pressure cannot exceed 5 PSI [0.35 BAR] for proper foam system operation. In the event of high fire pump inlet pressure, install a direct water tank fill connection and operate the foam system using the on-board water tank.

General Operating Tips for ATP Foam Systems

- ▶ While operating this system, if at any time the discharge flow is changed, the metering valve must be changed accordingly.
- ▶ While operating this system, if all discharges are closed, the foam concentrate valve must be closed immediately. Otherwise foam concentrate will continue to be introduced into the water pump.

Foam System Shutdown Instructions

1. Close 2" [50 mm] foam concentrate supply valve from either the on-board tank or external foam source to the metering valve.
2. Close 2" [50 mm] water supply valve to eductor.

Foam System Flushing Instructions

1. Close 2" [50 mm] foam concentrate supply valves from the on-board tank and external foam source, if equipped.
2. Engage fire pump and establish water flow based on standard apparatus operating procedures.
3. Operate the fire pump at low pressure and clean out the foam pickup tube and pickup hose.
4. Open 2" [50 mm] water supply valve to eductor.
5. Open 2" [50 mm] flushing valve.
6. Open foam metering valve to flush position (handle will be on the right side of the dial).
7. Flush system until clear water is observed from each discharge outlet.

NOTE: Foam system controls should be labeled in accordance to the NFPA Color Standards.

Schematic/Instruction Plate Template

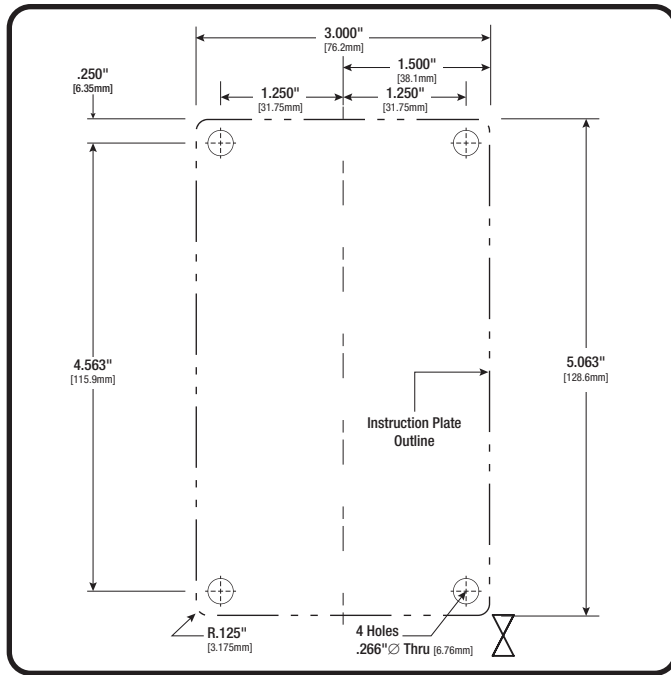

Figure 2

Metering Valve/Dial Template

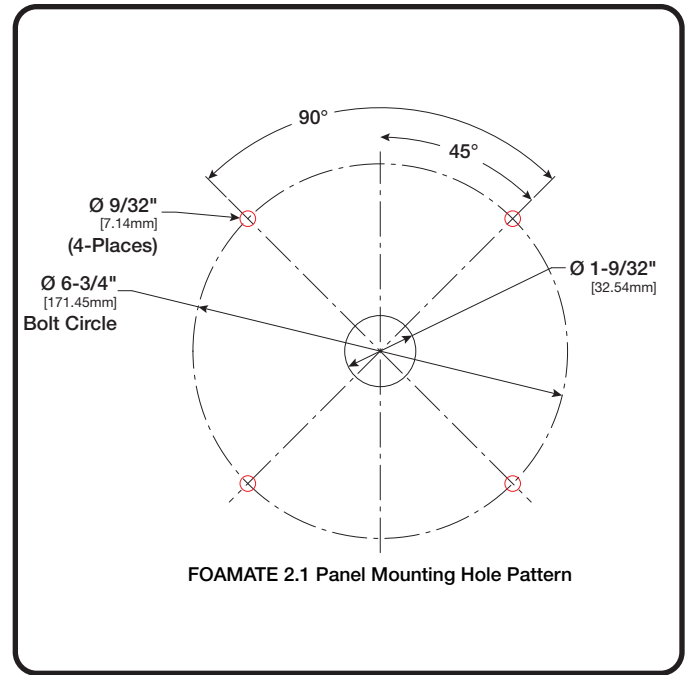
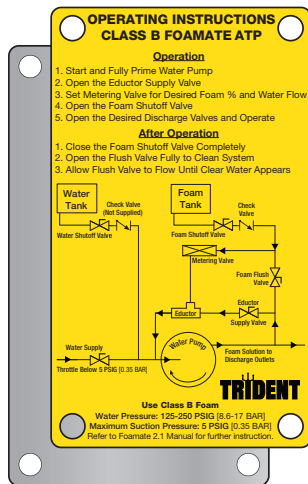

Figure 3



FOAMATE 2.1 ATP Part Numbers

Part #	2" Metering Valve	Dial Plate	Valves
31.014.2	Victaulic Ends	GPM	No
31.014.3	Victaulic Ends	[LPM]	No
31.014.4	Victaulic Ends	GPM	Yes
31.014.5	Victaulic Ends	[LPM]	Yes
31.014.12	FNPT Ends	GPM	No
31.014.13	FNPT Ends	[LPM]	No
31.014.14	FNPT Ends	GPM	Yes
31.014.15	FNPT Ends	[LPM]	Yes

FOAMATE 2.1 System Components

See Page 8 for Kit Part Numbers and Component Details

Item	Description	Quantity
1	2" Foam Concentrate Metering Valve	1
2	1½" x 2" Eductor	1
3	2" Brass Swing Type Check Valve	1
4	Schematic/Instruction Plate	1
5	Backing Plate	1

FOAMATE 2.1 System Components With Ball Valves

See Page 8 for Kit Part Numbers and Component Details

Item	Description	Quantity
1	2" Foam Concentrate Metering Valve	1
2	1½" x 2" Eductor	1
3	2" Brass Swing Type Check Valve	1
4	Schematic/Instruction Plate	1
5	Backing Plate	1
6	2" Brass Ball Type Shut Off Valve	3

Piping Schematic

FOAMATE 2.1 Piping Schematic

Shown below is the typical installation of the FOAMATE 2.1 ATP Foam Proportioning System.

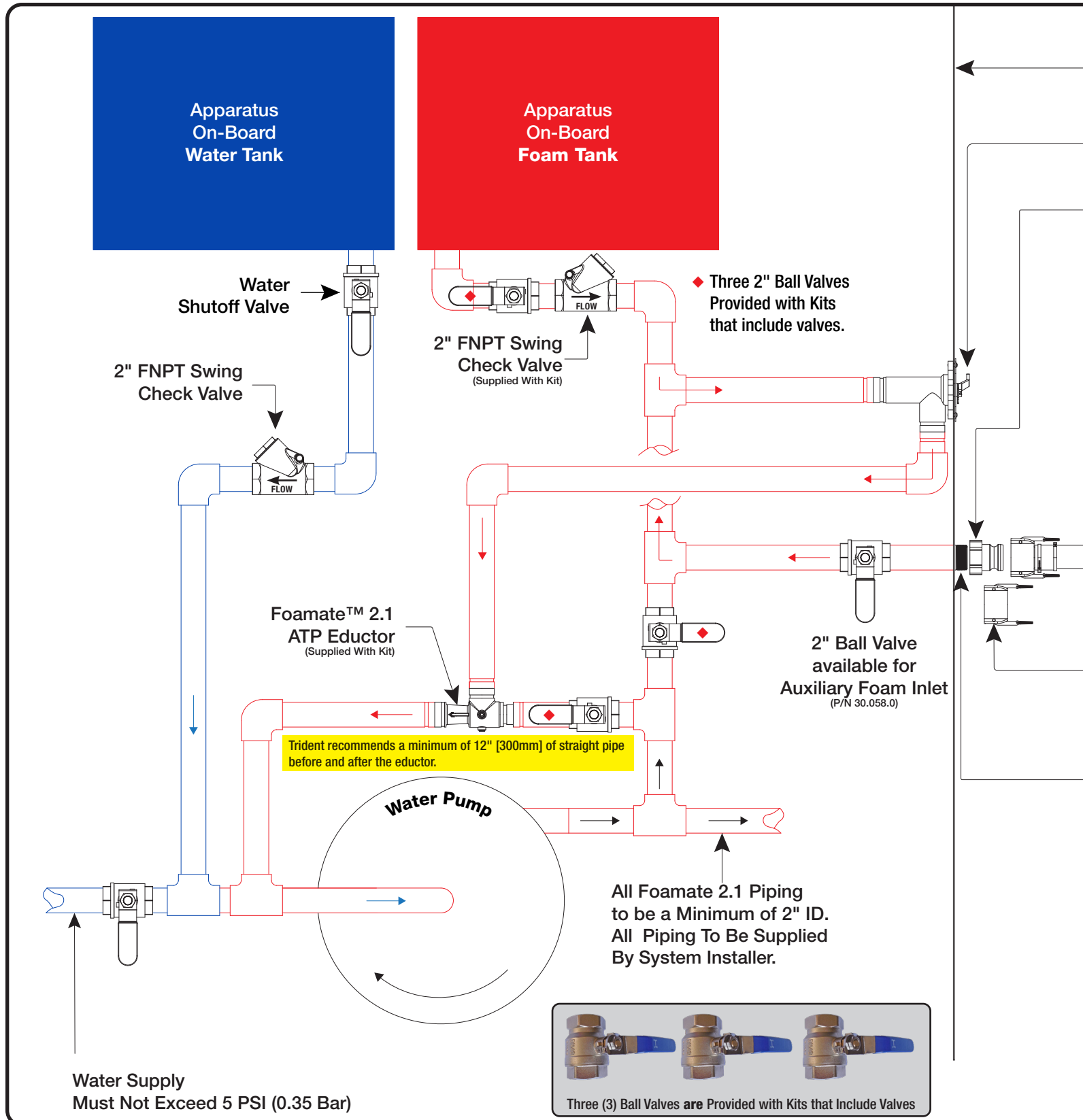

FOAMATE Model 2.1 Class B ATP Foam Proportioner

Available Optional Auxiliary Foam Concentrate Pickup Tube Assemblies

Benefits of an External Pickup Tube - Enhancing Your Foam System

- ▶ With a pick-up tube, the system can use either Class A or Class B foam; that is a huge advantage in operation capabilities!
- ▶ With a pick-up tube, there is no need to fill the on board tank while operating during an incident; this enhances safety by keeping members off of the top of the truck and improves efficiency and suppression capability.
- ▶ With a pick-up tube, training with water in place of foam makes your drills with the foam system very easy, convenient and inexpensive. Your on-board tank foam supply remains intact and your cleanup / back in service time is diminished. Also, there are no environmental issues while training with water.

Pump Panel

Foamate 2.1 ATP
2" Metering Valve
(Panel Mounted, Supplied With Kit)

2" Male Camlock Plug
with 2" FNPT Thread
for Connection to
System Piping

(Supplied With Pick-up Kit)

FOAMATE 2.1 ATP Auxiliary Foam Pickup Kits

Part #	Description
10.010.1	2" x 10' Pickup Hose and Pickup Tube Without Ball Valve
10.010.2	2" x 10' Pickup Hose and Pickup Tube With Ball Valve

Auxiliary Foam Concentrate Supplies

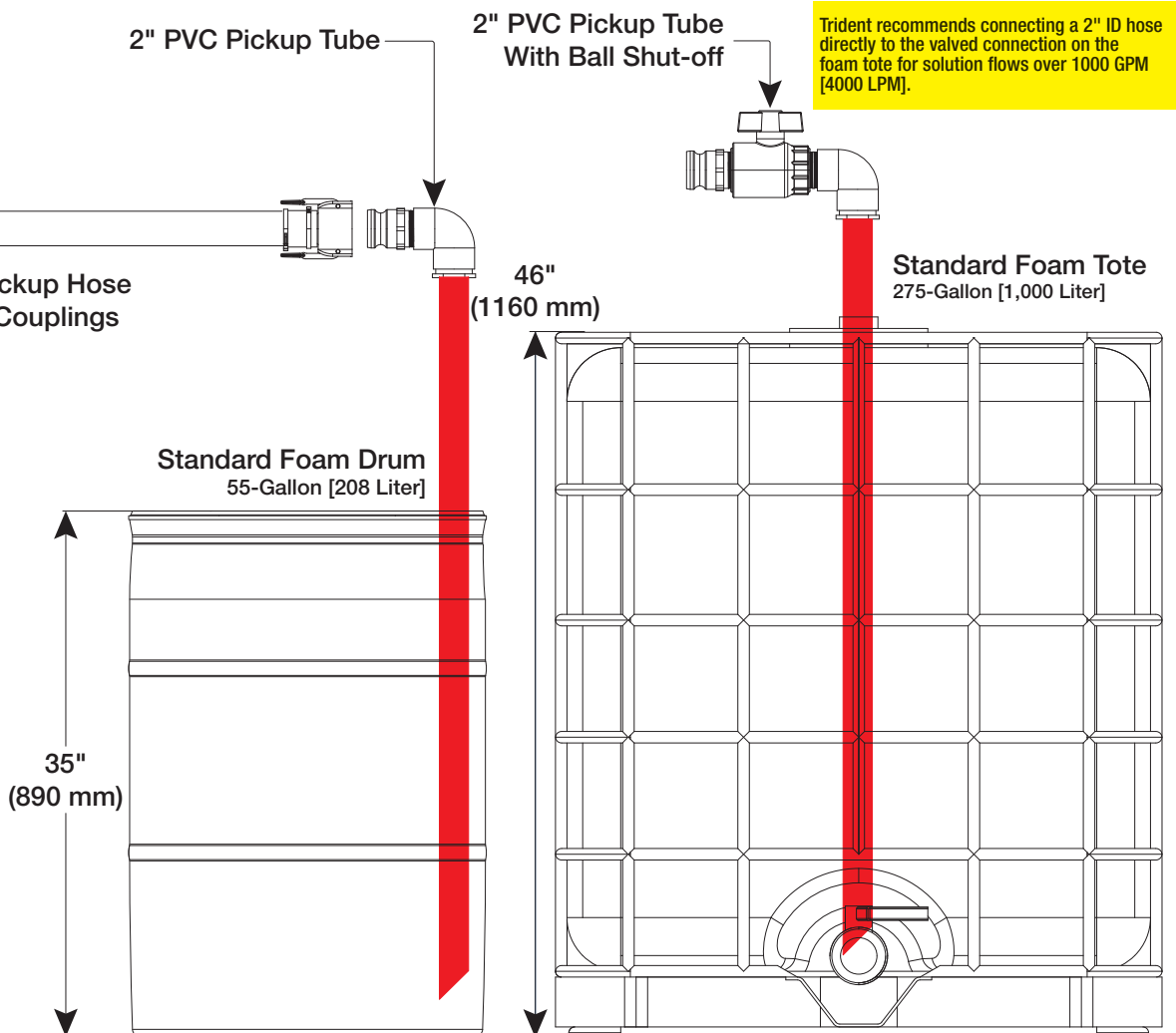

Model Numbers and Parts Listing

GPM/LPM Units Without Ball Valves

31.014.2 Foamate 2.1 ATP System, VIC Ends, GPM Flow Rates, Without Ball Valves		
Part Number	Description	Qty.
30.043.4	2" Metering Valve, VIC Ends	1
31.005.5	1½" x 2" Eductor, VIC Ends	1
02.028.1	Label, Foamate 2.1 GPM Flow Rates	1
02.023.1	Label, Foamate 2.1 Instruction	1
02.023.2	Backing Plate, Label	1
30.064.0	2" FNPT Check Valve	1

GPM/LPM Units With Ball Valves

31.014.4 Foamate 2.1 ATP System, VIC Ends, GPM Flow Rates, With Ball Valves		
Part Number	Description	Qty.
30.043.4	2" Metering Valve, VIC Ends	1
31.005.5	1½" x 2" Eductor, VIC Ends	1
02.028.1	Label, Foamate 2.1 GPM Flow Rates	1
02.023.1	Label, Foamate 2.1 Instruction	1
02.023.2	Backing Plate, Label	1
30.064.0	2" FNPT Check Valve	1
30.058.0	2" FNPT Ball Valve	3

31.014.3 Foamate 2.1 ATP System, VIC Ends, LPM Flow Rates, Without Ball Valves		
Part Number	Description	Qty.
30.043.4	2" Metering Valve, VIC Ends	1
31.005.5	1½" x 2" Eductor, VIC Ends	1
02.028.2	Label, Foamate 2.1 LPM Flow Rates	1
02.023.1	Label, Foamate 2.1 Instruction	1
02.023.2	Backing Plate, Label	1
30.064.0	2" FNPT Check Valve	1

31.014.5 Foamate 2.1 ATP System, VIC Ends, LPM Flow Rates, With Ball Valves		
Part Number	Description	Qty.
30.043.4	2" Metering Valve, VIC Ends	1
31.005.5	1½" x 2" Eductor, VIC Ends	1
02.028.2	Label, Foamate 2.1 LPM Flow Rates	1
02.023.1	Label, Foamate 2.1 Instruction	1
02.023.2	Backing Plate, Label	1
30.064.0	2" FNPT Check Valve	1
30.058.0	2" FNPT Ball Valve	3

31.014.12 Foamate 2.1 ATP System, FNPT Ends, GPM Flow Rates, Without Ball Valves		
Part Number	Description	Qty.
30.043.5	2" Metering Valve, FNPT Ends	1
31.005.5	1½" x 2" Eductor, VIC Ends	1
02.028.1	Label, Foamate 2.1 GPM Flow Rates	1
02.023.1	Label, Foamate 2.1 Instruction	1
02.023.2	Backing Plate, Label	1
30.064.0	2" FNPT Check Valve	1

31.014.14 Foamate 2.1 ATP System, FNPT Ends, GPM Flow Rates, With Ball Valves		
Part Number	Description	Qty.
30.043.5	2" Metering Valve, FNPT Ends	1
31.005.5	1½" x 2" Eductor, VIC Ends	1
02.028.1	Label, Foamate 2.1 GPM Flow Rates	1
02.023.1	Label, Foamate 2.1 Instruction	1
02.023.2	Backing Plate, Label	1
30.064.0	2" FNPT Check Valve	1
30.058.0	2" FNPT Ball Valve	3

31.014.13 Foamate 2.1 ATP System, FNPT Ends, LPM Flow Rates, Without Ball Valves		
Part Number	Description	Qty.
30.043.5	2" Metering Valve, FNPT Ends	1
31.005.5	1½" x 2" Eductor, VIC Ends	1
02.028.2	Label, Foamate 2.1 LPM Flow Rates	1
02.023.1	Label, Foamate 2.1 Instruction	1
02.023.2	Backing Plate, Label	1
30.064.0	2" FNPT Check Valve	1

31.014.15 Foamate 2.1 ATP System, FNPT Ends, LPM Flow Rates, With Ball Valves		
Part Number	Description	Qty.
30.043.5	2" Metering Valve, FNPT Ends	1
31.005.5	1½" x 2" Eductor, VIC Ends	1
02.028.2	Label, Foamate 2.1 LPM Flow Rates	1
02.023.1	Label, Foamate 2.1 Instruction	1
02.023.2	Backing Plate, Label	1
30.064.0	2" FNPT Check Valve	1
30.058.0	2" FNPT Ball Valve	3

Metering Valve Details

Exploded View of Metering Valve with Part Numbers

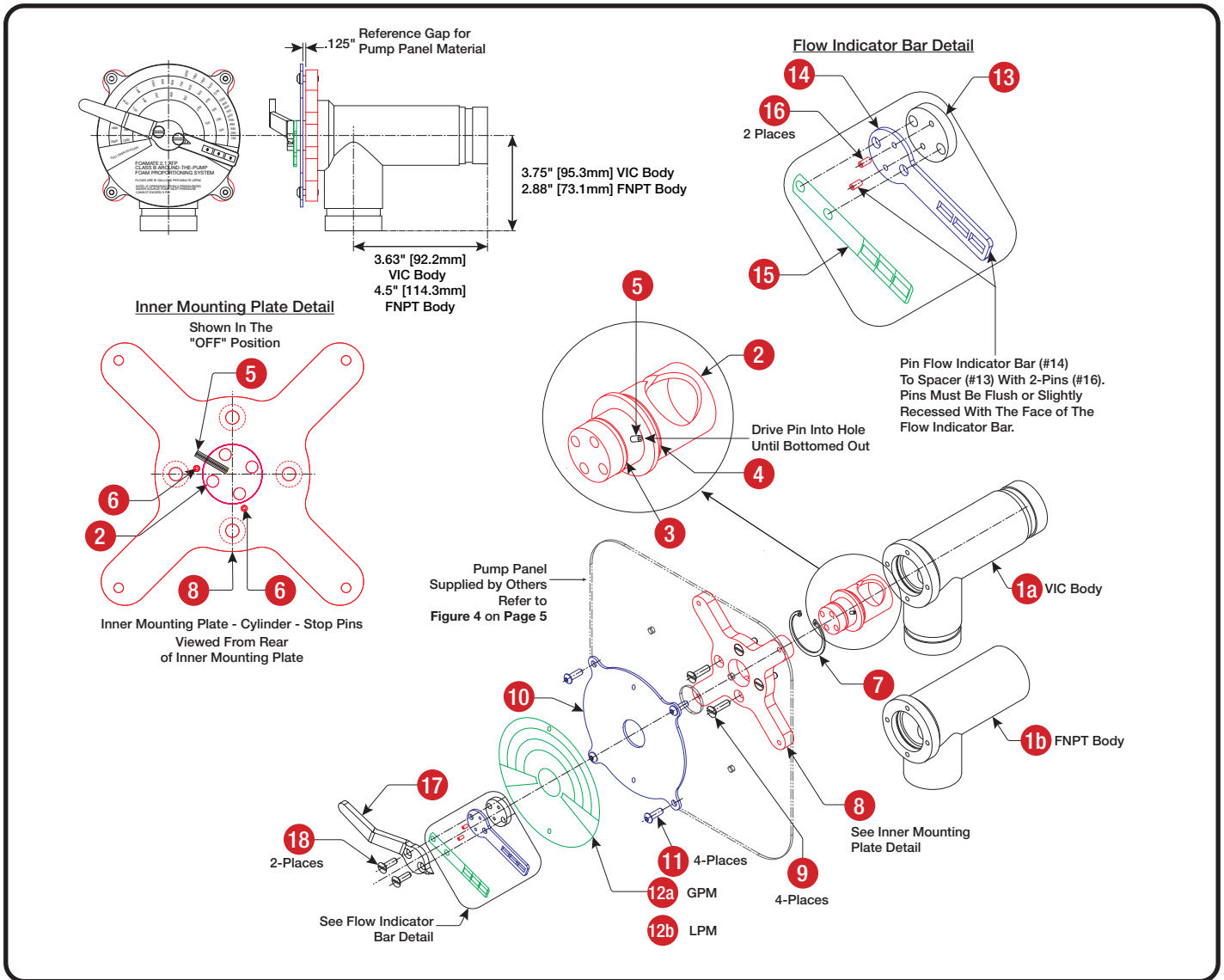

Figure 5

Item	Qty	Part #	Description	Material	Item	Qty	Part #	Description	Material
1a	1	07.017.7	Body, 2-Inch Foam Bypass Valve, VIC	Brass	11	4	04.117.0	Screw, Machine, Button Head, SS, ¼-20 x ¾" Long	Stainless
1b	1	07.017.8	Body, 2-Inch Foam Bypass Valve, FNPT	Brass	12a	1	02.028.1	Label, Dial Plate, Flow Graduations - GPM	Poly
2	1	12.005.2	Cylinder, 2-Inch Bypass Valve	Brass	12b	1	02.028.2	Label, Dial Plate, Flow Graduations - LPM	Poly
3	1	26.119.1	O-Ring, -119	EPDM	13	1	24.013.0	Brass Spacer ¼", Flow Indicator Bar	Brass
4	1	26.125.1	O-Ring, -125	EPDM	14	1	02.028.3	Bar, Flow Rate/Injection Indicator	Stainless
5	1	17.003.6	Slotted Spring Pin, ⅛"Ø x ¾" Long	Stainless	15	1	02.028.4	Label, Flow Rate/Injection Indicator	Poly
6	2	17.003.5	Slotted Spring Pin, ⅛"Ø x ½" Long	Stainless	16	2	17.003.8	Slotted Spring Pin, ⅛"Ø x ¼" Long	Stainless
7	1	04.046.0	Retaining Ring, Internal, HO-187	Stainless	17	1	19.010.0	Handle/Pointer, Chrome Plated	Plated Brass
8	1	18.020.1	Inner Mntg. Plate, Alum, 2-Inch Foam Bypass Valve	Powder Coat	18	2	04.118.0	Screw, Machine, Flat Head, SS, M6-1 x 20mm Long	Stainless
9	4	04.116.0	Screw, Machine, Flat Head, SS, ¼-20 x 1" Long	Stainless		1	30.043.4	2" Metering Valve Assembly, VIC Ends	Brass
10	1	02.028.0	Outer Mounting Plate, Flow Indicator Label	Stainless		1	30.043.5	2" Metering Valve Assembly, FNPT Ends	Brass

Foam System Maintenance

The simplistic design of the Trident FOAMATE 2.1 Around-The-Pump foam system requires very little maintenance. The effects of dried foam concentrates on valves can hinder proper system operation, so it is strongly recommended that the system be thoroughly flushed after each use. There is no other routine system maintenance required.

Foamate 2.1 Rebuild Kit - Part #27.007.9

O-Rings and Retaining Ring

For a detailed view of all Metering Valve Components, see Figure 5 on Page 9.

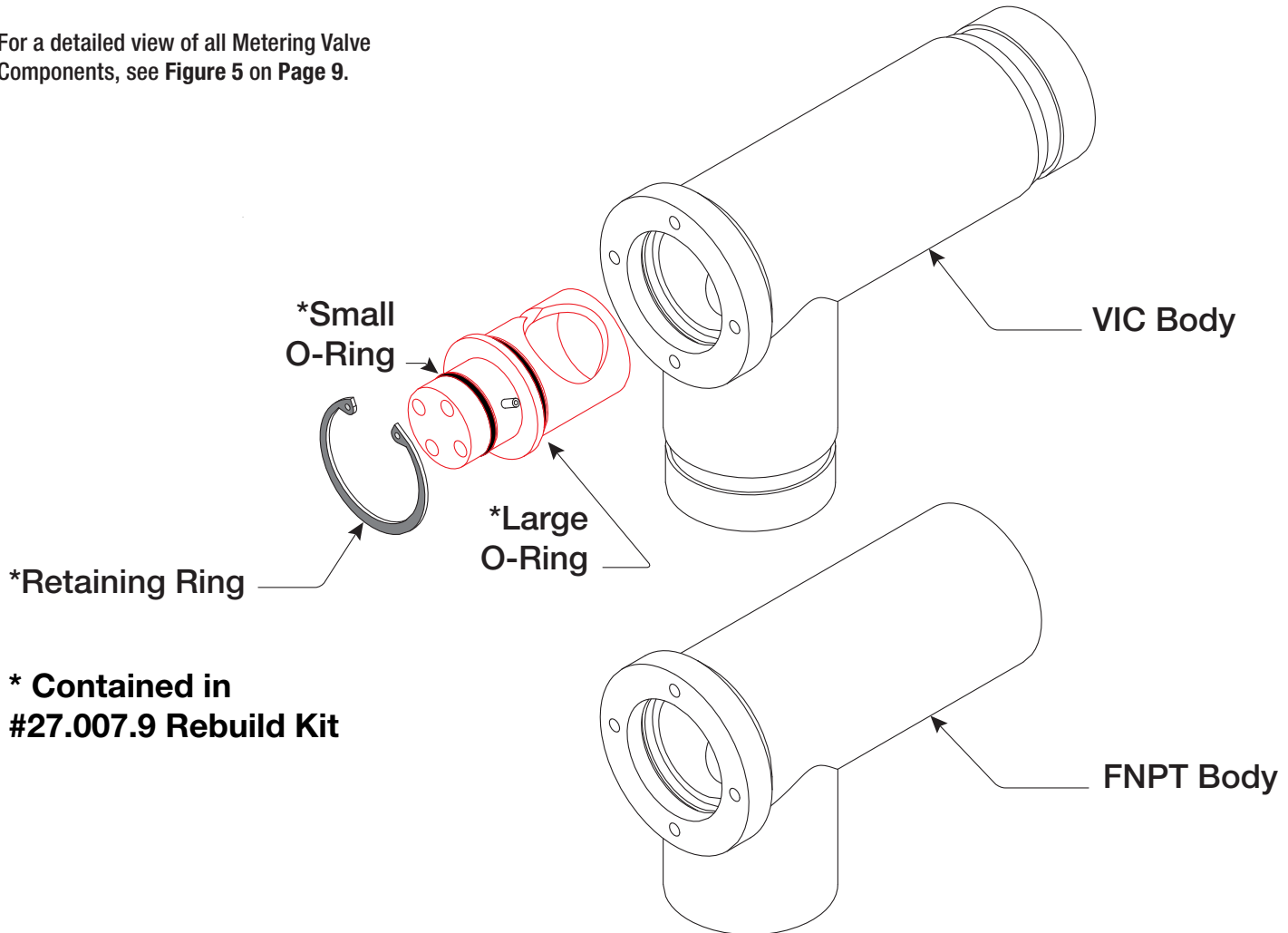

*** Contained in
#27.007.9 Rebuild Kit**

Foamate 2.1 O-Ring Replacement Instructions

- Carefully read the following instructions and review metering valve exploded view on **Page #9** prior to valve disassembly.
- Always practice standard lock-out/tag-out procedures when doing any apparatus service.
- Foam tank shut-off valve must be closed.
- Place metering valve in the closed position.
- Refer to exploded view of metering valve on **Page #9** prior to metering valve disassembly. Make note of all component positions and match mark all components during disassembly to maintain correct orientation during reassembly.
- Remove two (2) screws from metering valve handle and remove handle and flow indicator bar.
- Remove four (4) screws from metering valve flow indicator outer mounting plate.
- Remove four (4) screws from inner mounting plate/end cap.
- Remove internal snap ring from metering valve body.
- Pull cylinder from valve body.
- Remove and replace both O-Rings, applying a small amount of lubricant to each O-Ring. Use Parker Super O-Lube or equal. See sketch above for proper O-Ring placement.
- Reinstall all components in reverse order of disassembly, maintaining original orientation.
- Check system for proper operation.

Other Foam System Products

GP Series™ Foam Pumps

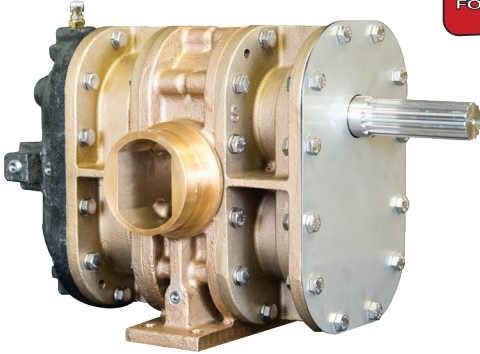

Model U
Universal Mount

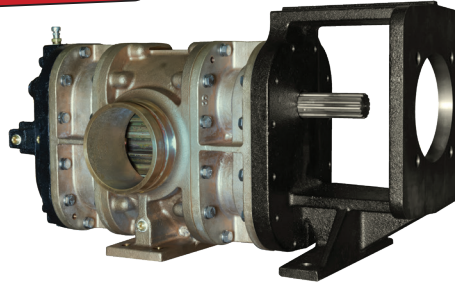

Model H
Hydraulic Mount

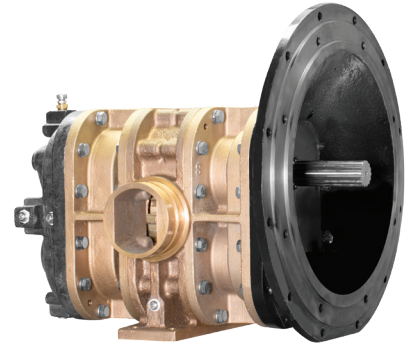

Model M
Bell Housing Mount

FOAMATE 1.0 ATP Class A Foam System

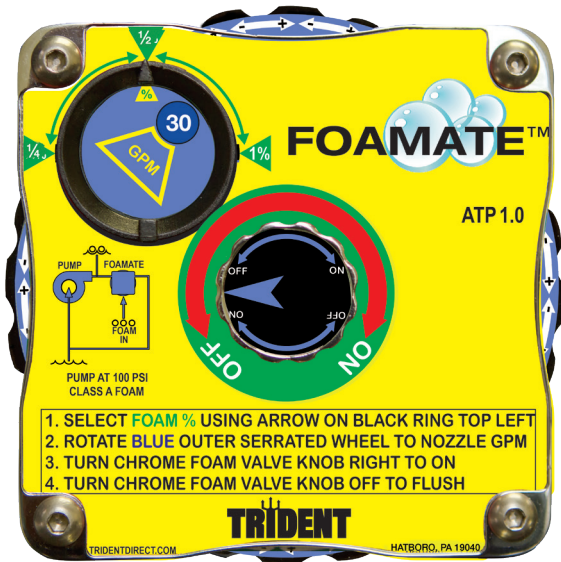

FOAMATE 2.1 Installed



Contact Us For Details On These And Other Foam System Products

Trident Emergency Products, LLC

2940 Turnpike Drive | Suite #9 | Hatboro, PA 19040 USA
215-293-0700 Phone
215-293-0701 Fax
sales@tridentdirect.com Email

TridentDirect.com



<https://www.facebook.com/tridentemergency>

Document: 99.014.1



World Class
Fire Industry
Products

Revised February 19, 2021
Foamate™ is a trademark of
Trident Emergency Products, LLC