

REVISIONS				
REV	DESCRIPTION	DATE	DRAWN BY	APPROVED

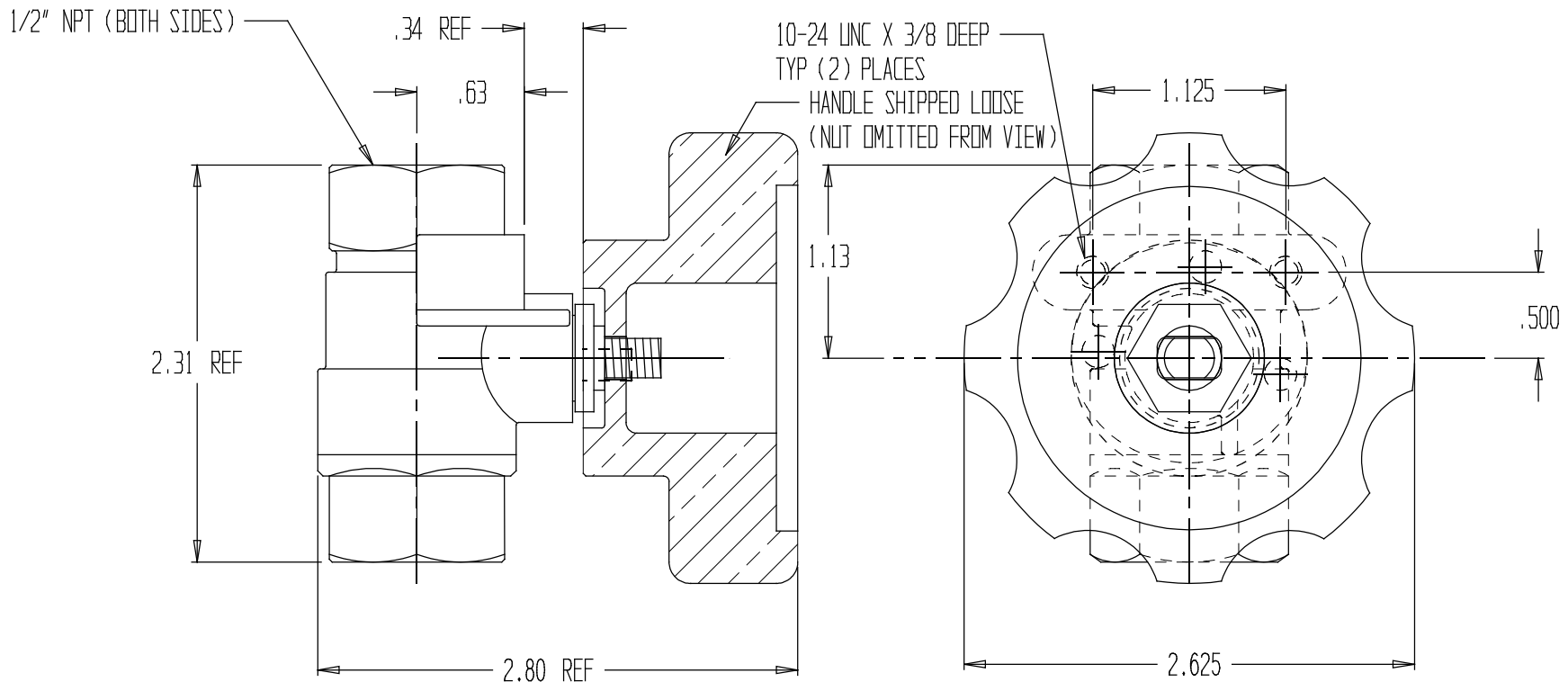

1/2" PANEL MOUNT BALL VALVE

REPORT ERRORS & CHANGES
 REMOVE ALL SHARP EDGES
 UNLESS OTHERWISE SPECIFIED
 ALL DIMENSIONS ARE IN INCHES

STANDARD TOLERANCES:

DECIMALS	ANGLES
.XX ± .030	± 1/2°
.XXX ± .015	

DRAWING NOT TO BE REPRODUCED OR USED TO MAKE OTHER DRAWINGS OR MACHINERY		SIZE A	DWG NO. 30.007.2	REV .
DRAWN BY MS	DATE 06/29/2003	SCALE 1:1	SHEET 1 OF 1	
CHECKED BY MS				