

REVISIONS				
REV	DESCRIPTION	DATE	DRAWN BY	APPROVED

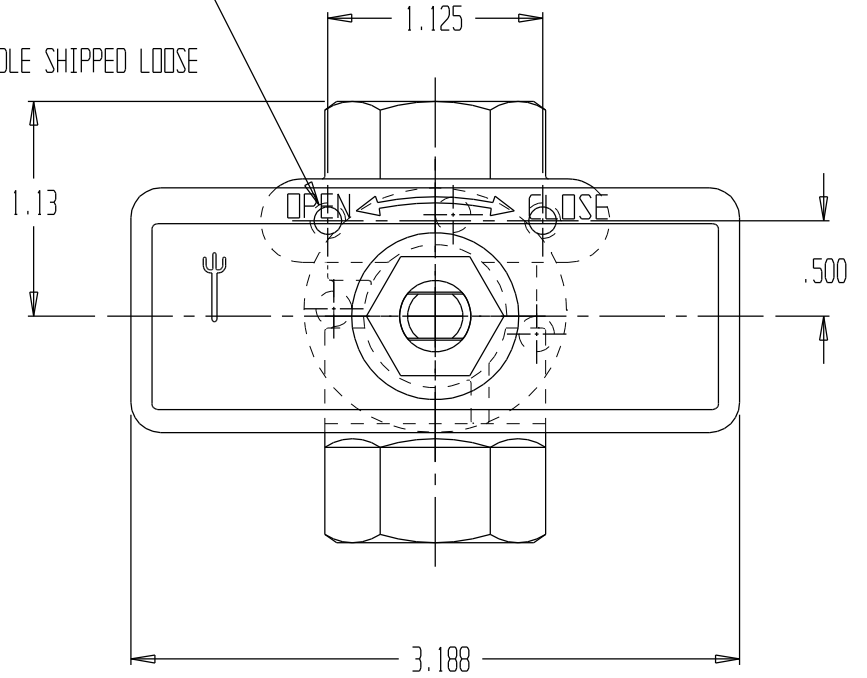
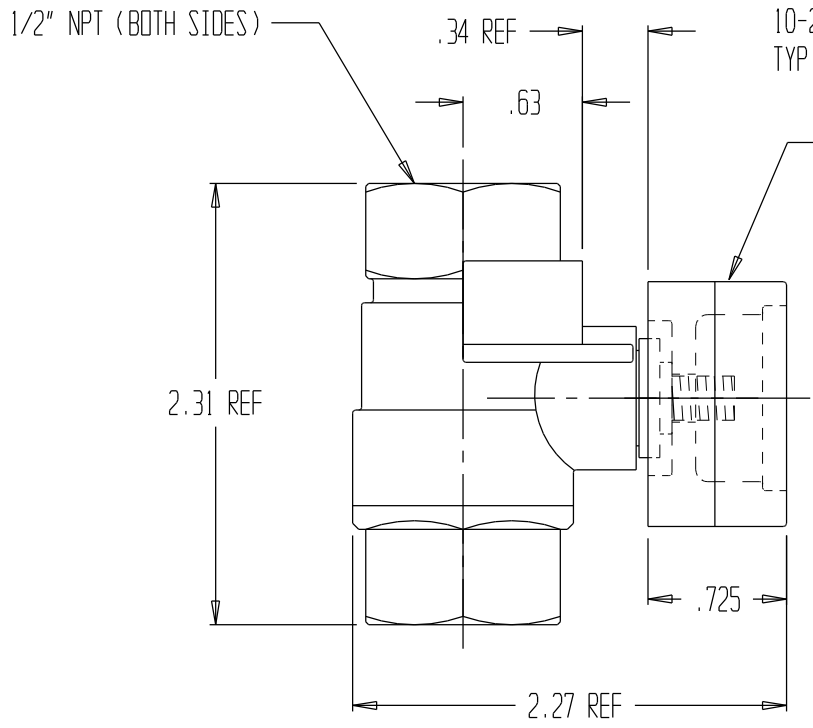

# 1/2" PANEL MOUNT BALL VALVE

REPORT ERRORS & CHANGES  
REMOVE ALL SHARP EDGES  
UNLESS OTHERWISE SPECIFIED  
ALL DIMENSIONS ARE IN INCHES

STANDARD TOLERANCES:

DECIMALS	ANGLES
.XX ± .030	± 1/2°
.XXX ± .015	

COPYRIGHT © DRAWING NOT TO BE REPRODUCED OR USED TO MAKE OTHER DRAWINGS OR MACHINERY		SIZE A	DWG NO.	30.007.1	REV .
DRAWN BY MS	CHECKED BY MS	DATE 05/24/2001	SCALE 1:1	SHEET 1 OF 1	