

REVISIONS				
REV	DESCRIPTION	DATE	DRAWN BY	APPROVED

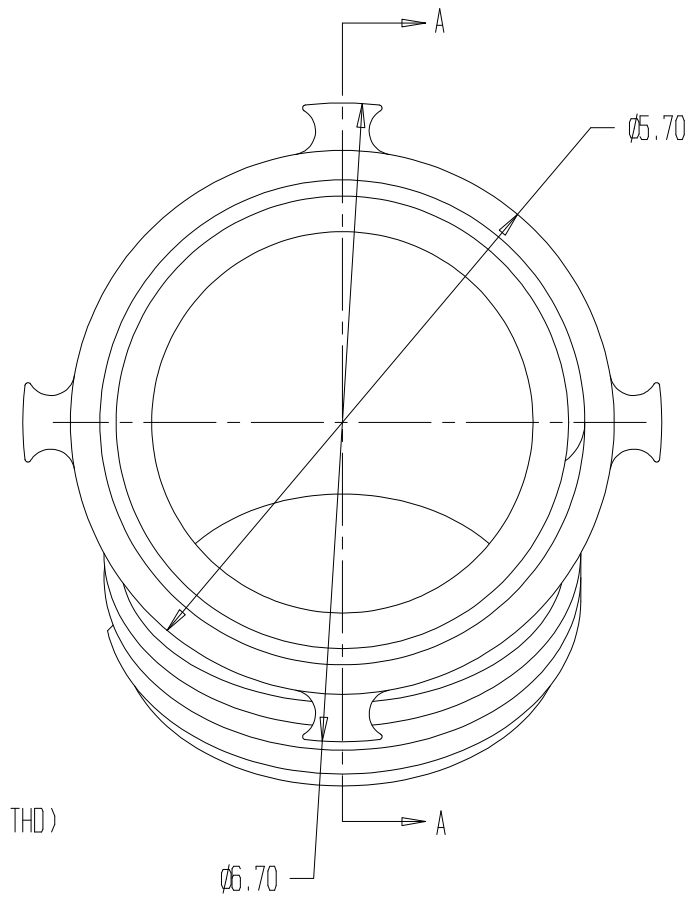
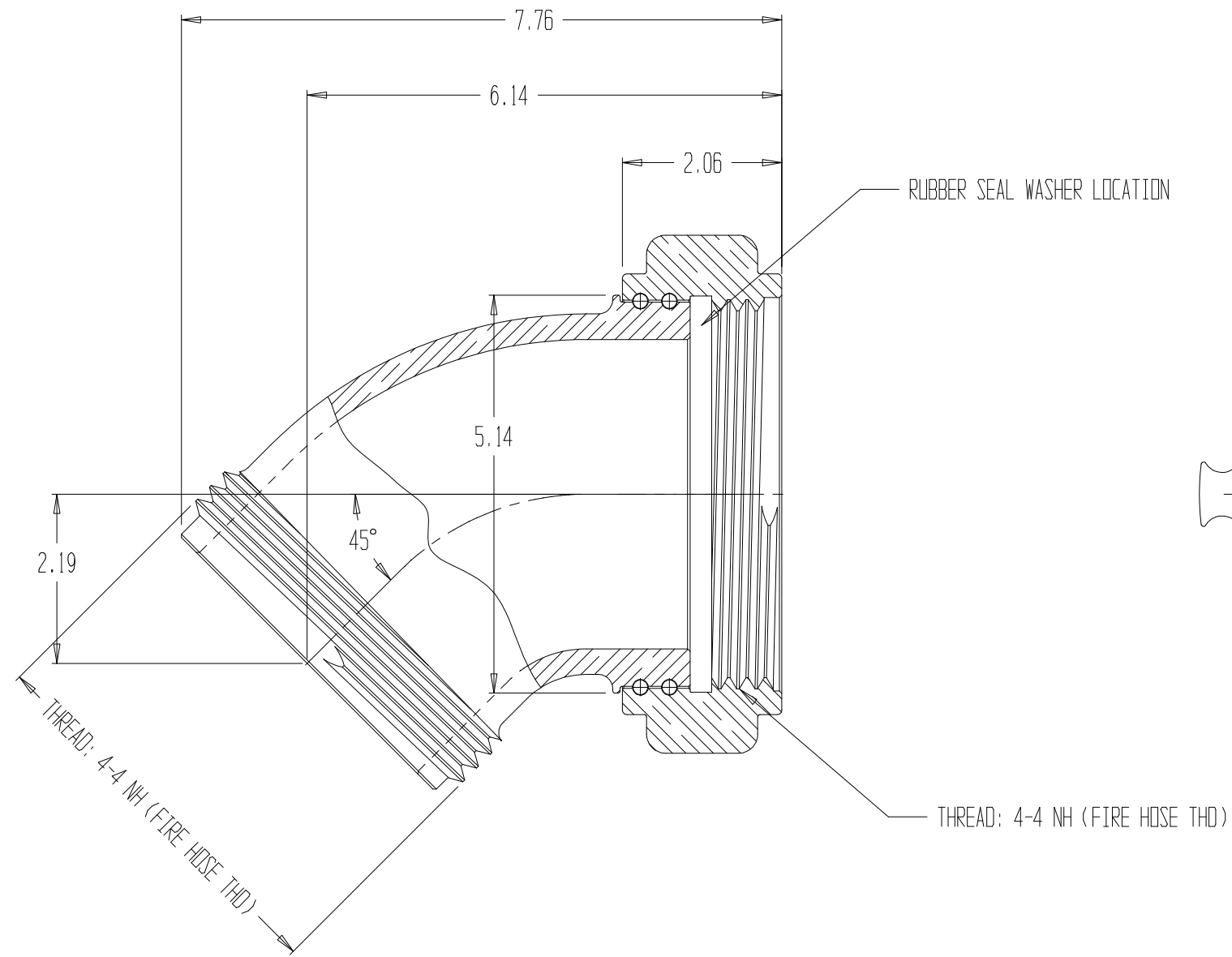

NOTES:

- 1) CHROME PLATED
- 2) MATERIAL: BRASS
- 3) BALL MATERIAL: STAINLESS
- 6) RUBBER WASHER INCLUDED AND INSTALLED

	ELBOW, 4" NH X 45°		
	REPORT ERRORS & CHANGES REMOVE ALL SHARP EDGES UNLESS OTHERWISE SPECIFIED ALL DIMENSIONS ARE IN INCHES	STANDARD TOLERANCES: DECIMALS .XX ± .030 .XXX ± .015	ANGLES ± 1/2°
COPYRIGHT © DRAWING NOT TO BE REPRODUCED OR USED TO MAKE OTHER DRAWINGS OR MACHINERY	SIZE B	DWG NO. 01.058.0PC	REV .
DRAWN BY MS	CHECKED BY MS	DATE 10/02/2002	SCALE 1:2 SHEET 1 OF 1