

REVISIONS				
REV	DESCRIPTION	DATE	DRAWN BY	APPROVED

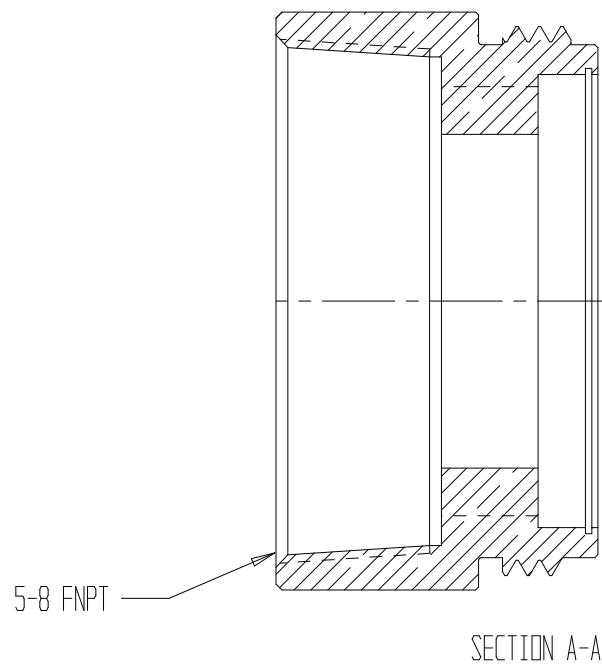
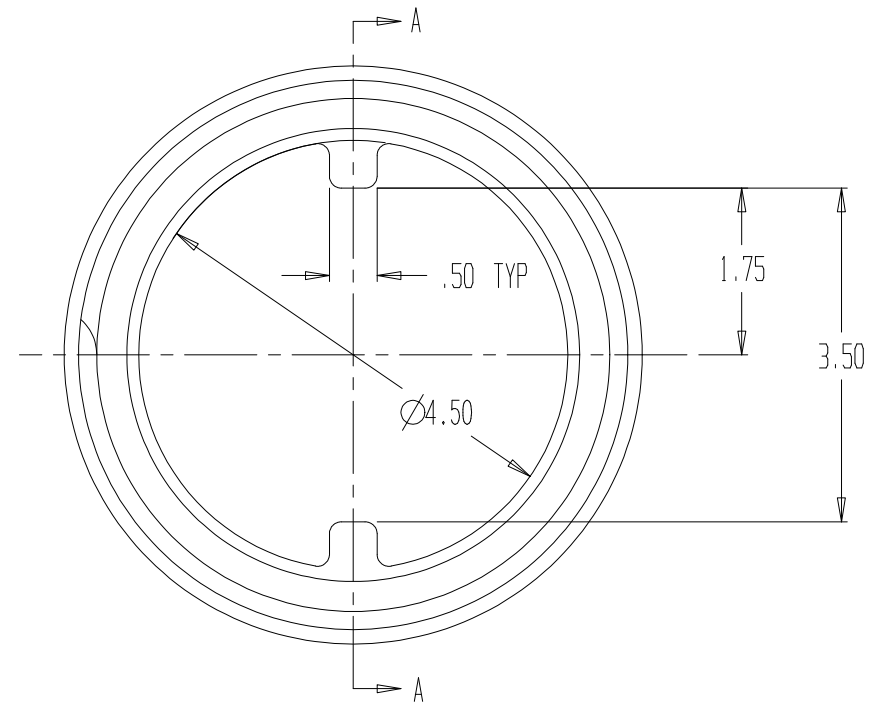
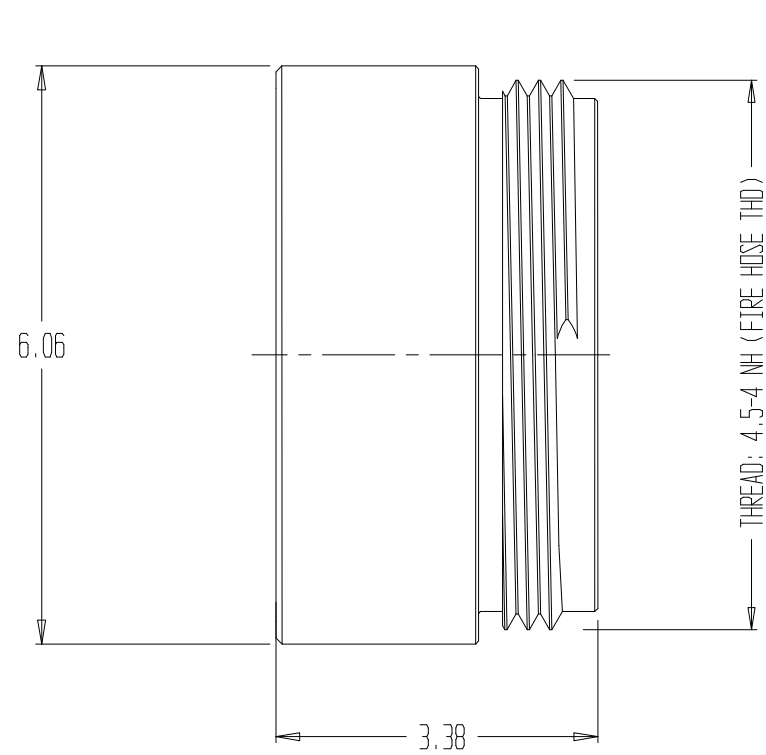

- NOTES:
- 1) CHROME PLATED
 - 2) MATERIAL: BRASS
 - 3) STRAINER INCLUDED, NOT SHOWN

	ADAPTER, 5" FNPT x 4.5" MNH		
	REPORT ERRORS & CHANGES REMOVE ALL SHARP EDGES UNLESS OTHERWISE SPECIFIED ALL DIMENSIONS ARE IN INCHES	STANDARD TOLERANCES: DECIMALS .XX ± .030 .XXX ± .015	ANGLES ± 1/2°
COPYRIGHT © DRAWING NOT TO BE REPRODUCED OR USED TO MAKE OTHER DRAWINGS OR MACHINERY	SIZE B	DWG NO. 01.035.5PC	REV .
DRAWN BY MS CHECKED BY MS	DATE 04/25/2002	SCALE 1:2	SHEET 1 OF 1