

REVISIONS				
REV	DESCRIPTION	DATE	DRAWN BY	APPROVED

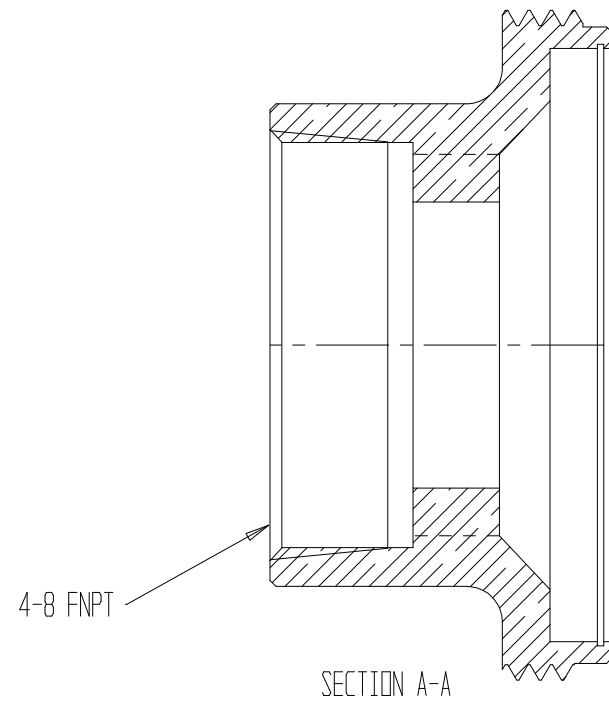
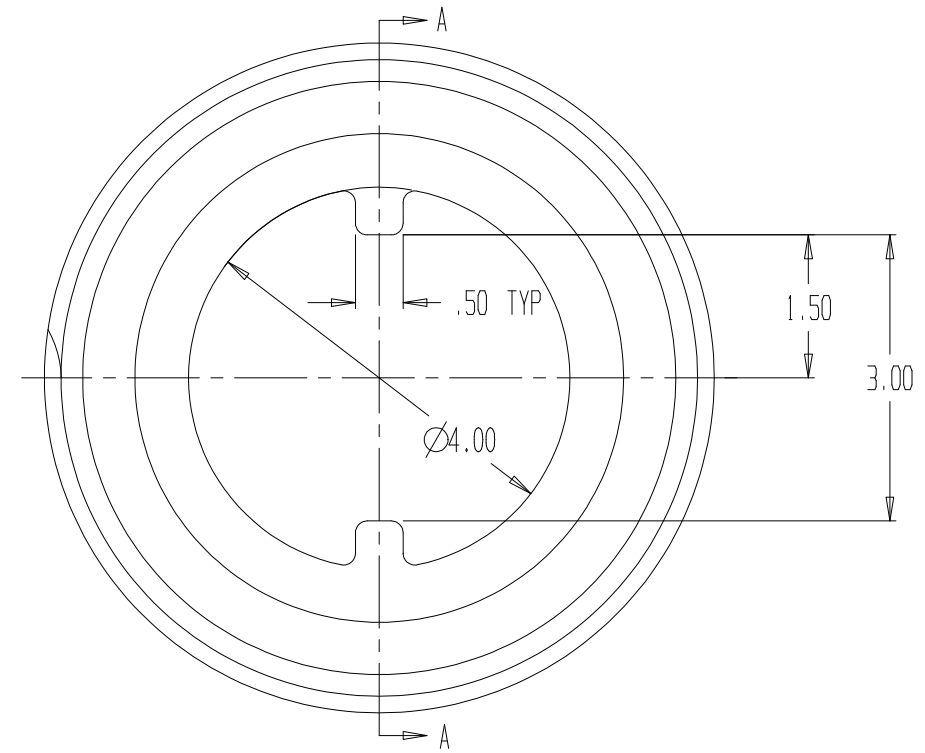
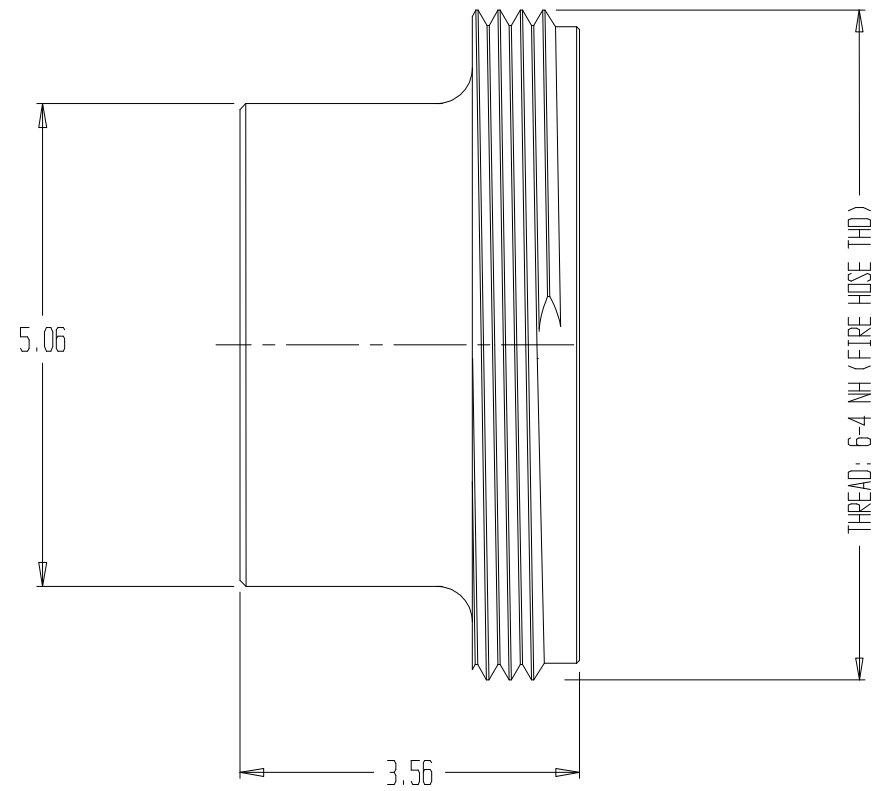

NOTES:

- 2) CHROME PLATED
- 3) MATERIAL: BRASS

		ADAPTER, 4" FNPT X 6" MNH		
		REPORT ERRORS & CHANGES REMOVE ALL SHARP EDGES UNLESS OTHERWISE SPECIFIED ALL DIMENSIONS ARE IN INCHES	STANDARD TOLERANCES: .XX ± .030 .XXX ± .015	ANGLES ± 1/2°
COPYRIGHT © DRAWING NOT TO BE REPRODUCED OR USED TO MAKE OTHER DRAWINGS OR MACHINERY		SIZE B	DWG NO. 01.034.0PC	REV .
DRAWN BY MS	CHECKED BY MS	DATE 04/25/2002	SCALE 1:2	SHEET 1 OF 1