

SECTION A-A

REVISIONS				
REV	DESCRIPTION	DATE	DRAWN BY	APPROVED
.
.

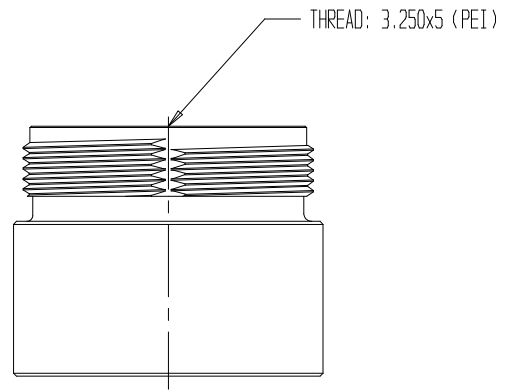

- NOTES:
 1) MATERIAL: BRASS
 3) CHROME PLATED



ADAPTER-3.25 X 5 TPI M X 2.5FNPT

REPORT ERRORS & CHANGES
 REMOVE ALL SHARP EDGES
 UNLESS OTHERWISE SPECIFIED
 ALL DIMENSIONS ARE IN INCHES

STANDARD TOLERANCES:

DECIMALS	ANGLES
.XX ± .030	± 1/2°
.XXX ± .015	

DRAWING NOT TO BE REPRODUCED OR USED TO MAKE OTHER DRAWINGS OR MACHINERY		COPYRIGHT ©		SIZE	DWG NO.	REV
DRAWN BY	MS	DATE	05/27/2010	A	01.S01.20PC	.
CHECKED BY	MS	SCALE 1:2		SHEET 1 OF 1		